



Ministry of Environment and Energy
Male', Republic of Maldives.

ދިވެހިސަރުކާރުގެ ގެޒެޓް ގައި ބަޔާންކުރި ގޮތުގައި ހިމެނޭ ގޮތުން
މި ސަރުކާރުގެ ބޭނުންކުރާ ގޮތެވެ.

Reference Number: (IUL)438/1/2017/16

Project Number: OFIDPMU/2017/PH2-003

INVITATION FOR BIDS

Establishment of Island Waste Management Centres (IWMC's) in H.Dh. Kumundhoo

1. The Government of the Republic of Maldives has received financing from the OPEC Fund for International development (OFID) and intends to apply portion of the financing for eligible payments under the contract for **Establishment of Island Waste Management Centers (IWMC's) in H. Dh. Kumundhoo**
2. The Ministry of Environment and Energy (MEE), now invites sealed Bids from eligible and qualified Bidders for the works given below. Bidding is open to all bidders who fulfill qualification requirements given in Section 6A of Bid document, briefly stated below. The work to be performed under this Contract includes, but is not necessarily limited to, construction of Island Waste Management Centre according to the Bill of Quantities, Drawings and Technical Specifications in order to establish a proper and an efficient waste management system in the islands that are locally appropriate, environmentally sound and financially viable.
3. The Bidder shall furnish a Bid Security of the amount MVR 10,000 of this Invitation for Bids which shall be valid for 28 days beyond the validity of the Bid. The Amount of Performance Security required under the contract shall be 5% of the Contract Price. An Advance Payment of 10% of the contract price shall be provided upon submission of an Advance Payment Guarantee.
4. Interested eligible bidders may register by emailing to OFID Project Management Unit to the email address given at clause 9 (ofid.pmu@environment.gov.mv). Bidders must register before submission of proposal. Last date for registration will be 22nd March 2017. Bidders who do not register by this date will not be eligible to submit their bid proposal.
5. **Pre-bid meeting** will be held on **March 22, 2017, Wednesday at 1000hours** Maldivian time at the Ministry of Environment and Energy.
6. **Bid opening** Bids Shall be Valid for a period of **90 days** from the date of Bid of Opening and shall be delivered to the Ministry of Environment and Energy at the address specified in the clause 9 of this



1 ސަރުކާރުގެ ގެޒެޓް ގައި ބަޔާންކުރި ގޮތެވެ 1



Green Building, Handhuvaree Hingun,
Maafannu, Male', 20392, Republic of Maldives.

+ (960) 301 8300
+ (960) 301 8301
www.environment.gov.mv

މިނިސްޓްރީ އޮފް އެންވައިރަންމަންޓް އަންދު އެނަޖީ،
މާފަންނު، ޕްލާން 20392، ދިވެހިސަރުކާރުގެ ގެޒެޓް.

secretariat@environment.gov.mv
www.twitter.com/ENVgovMV
www.facebook.com/environment.gov.mv

Invitation for Bids, on **1300hrs**, Maldivian time on **April 12, 2017**, at which time they will be opened in the presence of the Bidders who wish to attend the bid opening. Late bids will be rejected.

7. International Competitive Bidding (ICB) will be conducted in accordance with the OFID Procurement Guideline (November 1982), Single Stage One envelope bidding procedure.
8. Bidders may obtain further information from the following address:
OFID Project Management Unit,
Ministry of Environment and Energy,
Green Building, Handhuvaree Hingun, Maafannu,
Male', Maldives
Tel: 3018453/ 3018454
Fax: 3018301
Email: ofid.pmu@environment.gov.mv
9. This Invitation for Bids will be uploaded in the Ministry of Environment and Energy website www.environment.gov.mv

March 12, 2017



1 ސަވަދު ސަވަދު ސަވަދު 2



Green Building, Handhuvaree Hingun,
Maafannu, Male', 20392, Republic of Maldives.

+ (960) 301 8300

+ (960) 301 8301

www.environment.gov.mv

ޖުމްހޫރިއްޔާ ގެ ސަރުކާރުގެ ސަރުކާރުގެ ސަރުކާރު،
މާފަންނު، ހިންގު، 20392، ދިވެހިރާއްޖެ.

secretariat@environment.gov.mv

www.twitter.com/ENVgovMV

www.facebook.com/environment.gov.mv



Ministry of Finance and Treasury
Republic of Maldives

Bidding Document for Procurement of:

**CONSTRUCTION OF ISLAND WASTE
MANAGEMENT CENTRE AT
H.DH. KUMUNDHOO**

**Project: Provision of Water Supply, Sanitation and Solid
Waste Management Project (OFID Loan No. 1669PB)**

Project Number: OFIDPMU/2017/PH2-003

Employer: Ministry of Environment and Energy
Country: Maldives

Issued on: March 2017

Ministry of Environment and Energy

Standard Bidding Document

Table of Contents

PART 1 – Bidding Procedures.....	1-3
Section 1 - Instructions to Bidders	1-5
Section II - Bid Data Sheet (BDS)	1-31
Section III - Evaluation and Qualification Criteria	1-35
Section IV - Bidding Forms	1-45
Section V - Eligible Countries	1-74
PART 2 – Works Requirements	2-77
Section VII - Works Requirements	2-79
PART 3 – Conditions of Contract and Contract Forms	3-85
Section VIII. General Conditions of Contract	3-87
Section IX. Particular Conditions of Contract	3-88
Section X - Contract Forms	3-93

PART 1 – Bidding Procedures

Section 1 - Instructions to Bidders

Table of Contents

A.	General.....	7
1.	Scope of Bid	7
2.	Source of Funds	7
3.	Corrupt and Fraudulent Practices	8
4.	Eligible Bidders	8
5.	Eligible Materials, Equipment and Services	11
B.	Contents of Bidding Document	11
6.	Sections of Bidding Document.....	11
7.	Clarification of Bidding Document, Site Visit, Pre-Bid Meeting	12
8.	Amendment of Bidding Document.....	13
C.	Preparation of Bids.....	13
9.	Cost of Bidding.....	13
10.	Language of Bid	13
11.	Documents Comprising the Bid	13
12.	Letter of Bid and Schedules	14
13.	Alternative Bids.....	14
14.	Bid Prices and Discounts	15
15.	Currencies of Bid and Payment	16
16.	Documents Comprising the Technical Proposal	16
17.	Documents Establishing the Qualifications of the Bidder	16
18.	Period of Validity of Bids	17
19.	Bid Security.....	17
20.	Format and Signing of Bid.....	19
D.	Submission and Opening of Bids.....	20
21.	Sealing and Marking of Bids.....	20
22.	Deadline for Submission of Bids.....	20
23.	Late Bids	21
24.	Withdrawal, Substitution, and Modification of Bids.....	21
25.	Bid Opening	21
E.	Evaluation and Comparison of Bids	22
26.	Confidentiality.....	22

27.	Clarification of Bids	23
28.	Deviations, Reservations, and Omissions.....	23
29.	Determination of Responsiveness	23
30.	Nonconformities, Errors, and Omissions.....	24
31.	Correction of Arithmetical Errors	24
32.	Conversion to Single Currency	25
33.	Margin of Preference	25
34.	Subcontractors.....	25
35.	Evaluation of Bids	25
36.	Comparison of Bids	27
37.	Qualification of the Bidder	27
38.	Employer’s Right to Accept Any Bid, and to Reject Any or All Bids.....	27
F.	Award of Contract.....	27
39.	Award Criteria.....	27
40.	Notification of Award.....	27
41.	Signing of Contract.....	29
42.	Performance Security.....	29

Section I - Instructions to Bidders

A. General

1. **Scope of Bid**
 - 1.1 In connection with the Invitation for Bids **specified in the Bid Data Sheet (BDS)**, the Employer, as **specified in the BDS**, issues these Bidding Documents for the procurement of the Works as specified in Section VII, Works Requirements. The name, identification, and number of lots (contracts) of this International Competitive Bidding (ICB) process are **specified in the BDS**.
 - 1.2 Throughout this Bidding Document:
 - (a) the term “in writing” means communicated in written form and delivered against receipt;
 - (b) except where the context requires otherwise, words indicating the singular also include the plural and words indicating the plural also include the singular; and
 - (c) “day” means calendar day.
2. **Source of Funds**
 - 2.1 The Beneficiary or Recipient (hereinafter called “Beneficiary”) **specified in the BDS** has received or has applied for financing (hereinafter called “funds”) from the OPEC Funds for International Development (OFID) (hereinafter called “the Fund”) in an amount **specified in the BDS**, toward the project named **in the BDS**. The Beneficiary intends to apply a portion of the funds to eligible payments under the contract(s) for which these Bidding Documents are issued.
 - 2.2 Payment by the Fund will be made only at the request of the Beneficiary and upon approval by the Fund, and will be subject, in all respects, to the terms and conditions of the financing Agreement. The financing Agreement prohibits a withdrawal from the Financing/Loan/Grants (or other financing) account for the purpose of any payment to persons or entities, or for any import of goods, if such payment or import, to the knowledge of the Fund, is prohibited by a decision of the Organization. No party other than the Beneficiary shall derive any rights from the financing Agreement or have any claim to the proceeds of the financing (or other financing).

- 3. Corrupt and Fraudulent Practices**
- 3.1 The Fund requires compliance with its policy in regard to corrupt and fraudulent practices as set forth in Section VI.
- 3.2 In further pursuance of this policy, Bidders shall permit and cause its agents (whether declared or not), sub-contractors, sub-consultants, service providers, or suppliers and any personnel thereof, to permit the Fund to inspect all accounts, records and other documents relating to any prequalification process, bid submission, and contract performance (in the case of award), and to have them audited by auditors appointed by the Fund.
- 4. Eligible Bidders**
- 4.1 A Bidder may be a firm that is a private entity, a government-owned entity—subject to ITB 4.5—or any combination of such entities in the form of a joint venture (JV) under an existing agreement or with the intent to enter into such an agreement supported by a letter of intent. In the case of a joint venture, all members shall be jointly and severally liable for the execution of the Contract in accordance with the Contract terms. The JV shall nominate a Representative who shall have the authority to conduct all business for and on behalf of any and all the members of the JV during the bidding process and, in the event the JV is awarded the Contract, during contract execution. Unless specified in the BDS, there is no limit on the number of members in a JV.
- 4.2 A Bidder shall not have a conflict of interest. Any Bidder found to have a conflict of interest shall be disqualified. A Bidder may be considered to have a conflict of interest for the purpose of this bidding process, if the Bidder:
- (a) directly or indirectly controls, is controlled by or is under common control with another Bidder; or
 - (b) receives or has received any direct or indirect subsidy from another Bidder; or
 - (c) has the same legal representative as another Bidder; or
 - (d) has a relationship with another Bidder, directly or through common third parties, that puts it in a position to influence the bid of another Bidder, or influence the decisions of the Employer regarding this bidding process; or
 - (e) participates in more than one bid in this bidding process. Participation by a Bidder in more than one Bid will result in the disqualification of all Bids in which such Bidder is involved. However, this does not limit the inclusion of the same subcontractor in more than one bid; or

- (f) or any of its affiliates participated as a consultant in the preparation of the design or technical specifications of the works that are the subject of the bid; or
 - (g) or any of its affiliates has been hired (or is proposed to be hired) by the Employer or Beneficiary as Engineer for the Contract implementation;
 - (h) would be providing goods, works, or non-consulting services resulting from or directly related to consulting services for the preparation or implementation of the project specified in the BDS ITB 2.1 that it provided or were provided by any affiliate that directly or indirectly controls, is controlled by, or is under common control with that firm; or
 - (i) has a close business or family relationship with a professional staff of the Beneficiary (or of the project implementing agency, or of a recipient of a part of the financing) who: (i) are directly or indirectly involved in the preparation of the bidding documents or specifications of the contract, and/or the bid evaluation process of such contract; or (ii) would be involved in the implementation or supervision of such contract unless the conflict stemming from such relationship has been resolved in a manner acceptable to the Fund throughout the procurement process and execution of the contract.
- 4.3 A Bidder shall have the nationality of any country, subject to the restrictions pursuant to ITB 4.7 and in accordance with Section V. A Bidder shall be deemed to have the nationality of a country if the Bidder is constituted, incorporated or registered in and operates in conformity with the provisions of the laws of that country, as evidenced by its articles of incorporation (or equivalent documents of constitution or association) and its registration documents, as the case may be. This criterion also shall apply to the determination of the nationality of proposed sub-contractors or sub-consultants for any part of the Contract including related Services.
- 4.4 A Bidder that has been sanctioned by the Fund in accordance with the above ITB 3.1, including in accordance with the Fund's Guidelines on Preventing and Combating Corruption in Projects Financed by OFID financing and Grants ("Anti-Corruption Guidelines"), shall be ineligible to be prequalified for, bid for, or be awarded a Fund-financed contract or benefit from a Fund-financed contract, financially or otherwise, during such period of time as the Fund shall have determined. The list of debarred firms and individuals is available at the electronic address

specified in the BDS.

- 4.5 Bidders that are Government-owned enterprises or institutions in the Employer's Country may participate only if they can establish that they (i) are legally and financially autonomous (ii) operate under commercial law, and (iii) are not dependent agencies of the Employer. To be eligible, a government-owned enterprise or institution shall establish to the Fund's satisfaction, through all relevant documents, including its Charter and other information the Fund may request, that it: (i) is a legal entity separate from the government (ii) does not currently receive substantial subsidies or budget support; (iii) operates like any commercial enterprise, and, inter alia, is not obliged to pass on its surplus to the government, can acquire rights and liabilities, borrow funds and be liable for repayment of its debts, and can be declared bankrupt; and (iv) is not bidding for a contract to be awarded by the department or agency of the government which under their applicable laws or regulations is the reporting or supervisory authority of the enterprise or has the ability to exercise influence or control over the enterprise or institution.
- 4.6 A Bidder shall not be under suspension from bidding by the Employer as the result of the operation of a Bid-Securing Declaration.
- 4.7 Firms and individuals may be ineligible if so indicated in Section V and (a) as a matter of law or official regulations, the Beneficiary's country prohibits commercial relations with that country, provided that the Fund is satisfied that such exclusion does not preclude effective competition for the supply of goods or the contracting of works or services required; or (b) by the Boycott Regulations of the Organization of the Islamic Cooperation, the League of Arab States and the African Union, the Beneficiary's country prohibits any import of goods or contracting of works or services from that country, or any payments to any country, person, or entity in that country.
- 4.8 This bidding is open only to prequalified Bidders unless **specified in the BDS.**
- 4.9 A Bidder shall provide such evidence of eligibility satisfactory to the Employer, as the Employer shall reasonably request.

- 5. Eligible Materials, Equipment and Services**
- 5.1 The materials, equipment and services to be supplied under the Contract and financed by the Fund may have their origin in any country subject to the restrictions specified in Section V, Eligible Countries, and all expenditures under the Contract will not contravene such restrictions. At the Employer's request, Bidders may be required to provide evidence of the origin of materials, equipment and services.

B. Contents of Bidding Document

- 6. Sections of Bidding Document**
- 6.1 The Bidding Document consist of Parts 1, 2, and 3, which include all the Sections specified below, and which should be read in conjunction with any Addenda issued in accordance with ITB 8.

PART 1 Bidding Procedures

- Section I - Instructions to Bidders (ITB)
- Section II - Bid Data Sheet (BDS)
- Section III - Evaluation and Qualification Criteria
- Section IV - Bidding Forms
- Section V - Eligible Countries
- Section VI – Fund Policy-Corrupt and Fraudulent Practices

PART 2 Works Requirements

- Section VII - Works Requirements

PART 3 Conditions of Contract and Contract Forms

- Section VIII - General Conditions of Contract (GCC)
- Section IX - Particular Conditions of Contract (PCC)
- Section X - Contract Forms

- 6.2 The Invitation for Bids issued by the Employer is not part of the Bidding Document.
- 6.3 Unless obtained directly from the Employer, the Employer is not responsible for the completeness of the Bidding Documents, responses to requests for clarification, the minutes of the pre-Bid meeting (if any), or Addenda to the Bidding Documents in accordance with ITB 8. In case of any contradiction, documents obtained directly from the Employer shall prevail.
- 6.4 The Bidder is expected to examine all instructions, forms, terms, and specifications in the Bidding Documents and to furnish with its bid all information and documentation as is required by the Bidding Documents.

7. Clarification of Bidding Document, Site Visit, Pre-Bid Meeting

- 7.1 A Bidder requiring any clarification of the Bidding Documents shall contact the Employer in writing at the Employer's address **specified in the BDS** or raise its enquiries during the pre-bid meeting if provided for in accordance with ITB 7.4. The Employer will respond in writing to any request for clarification, provided that such request is received no later than fourteen (14) days prior to the deadline for submission of bids. The Employer shall forward copies of its response to all Bidders who have acquired the Bidding Documents in accordance with ITB 6.3, including a description of the inquiry but without identifying its source. If so **specified in the BDS**, the Employer shall also promptly publish its response at the web page **identified in the BDS**. Should the clarification result in changes to the essential elements of the Bidding Documents, the Employer shall amend the Bidding Documents following the procedure under ITB 8 and ITB 22.2
- 7.2 The Bidder is advised to visit and examine the Site of Works and its surroundings and obtain for itself on its own responsibility all information that may be necessary for preparing the bid and entering into a contract for construction of the Works. The costs of visiting the Site shall be at the Bidder's own expense.
- 7.3 The Bidder and any of its personnel or agents will be granted permission by the Employer to enter upon its premises and lands for the purpose of such visit, but only upon the express condition that the Bidder, its personnel, and agents will release and indemnify the Employer and its personnel and agents from and against all liability in respect thereof, and will be responsible for death or personal injury, loss of or damage to property, and any other loss, damage, costs, and expenses incurred as a result of the inspection.
- 7.4 If so **specified in the BDS**, the Bidder's designated representative is invited to attend a pre-bid meeting. The purpose of the meeting will be to clarify issues and to answer questions on any matter that may be raised at that stage.
- 7.5 The Bidder is requested to submit any questions in writing, to reach the Employer not later than one week before the meeting.
- 7.6 Minutes of the pre-bid meeting, if applicable, including the text of the questions asked by Bidders, without identifying the source, and the responses given, together with any responses prepared after the meeting, will be transmitted promptly to all Bidders who have acquired the Bidding Documents in accordance with ITB 6.3. Any modification to the Bidding Documents that may become necessary as a result of the pre-bid meeting shall be

made by the Employer exclusively through the issue of an Addendum pursuant to ITB 8 and not through the minutes of the pre-bid meeting. Nonattendance at the pre-bid meeting will not be a cause for disqualification of a Bidder.

- 8. Amendment of Bidding Document**
- 8.1 At any time prior to the deadline for submission of bids, the Employer may amend the Bidding Documents by issuing addenda.
- 8.2 Any addendum issued shall be part of the Bidding Documents and shall be communicated in writing to all who have obtained the Bidding Documents from the Employer in accordance with ITB 6.3. The Employer shall also promptly publish the addendum on the Employer's web page in accordance with ITB 7.1.
- 8.3 To give Bidders reasonable time in which to take an addendum into account in preparing their bids, the Employer should extend the deadline for the submission of bids, pursuant to ITB 22.2

C. Preparation of Bids

- 9. Cost of Bidding**
- 9.1 The Bidder shall bear all costs associated with the preparation and submission of its Bid, and the Employer shall not be responsible or liable for those costs, regardless of the conduct or outcome of the bidding process.
- 10. Language of Bid**
- 10.1 The Bid, as well as all correspondence and documents relating to the bid exchanged by the Bidder and the Employer, shall be written in the language specified in the BDS. Supporting documents and printed literature that are part of the Bid may be in another language provided they are accompanied by an accurate translation of the relevant passages in the language specified in the BDS, in which case, for purposes of interpretation of the Bid, such translation shall govern.
- 11. Documents Comprising the Bid**
- 11.1 The Bid shall comprise the following:
- (a) Letter of Bid and Appendix to Bid;
 - (b) completed Schedules as required, including priced Bill of Quantities, accordance with ITB 12 and 14;
 - (c) Bid Security or Bid Securing Declaration, in accordance with ITB 19.1;
 - (d) alternative bids, if permissible, in accordance with ITB 13;
 - (e) written confirmation authorizing the signatory of the Bid to

commit the Bidder, in accordance with ITB 20.2;

(f) documentary evidence in accordance with ITB 17 establishing the Bidder's continued qualified status or, if post-qualification applies, as specified in accordance with ITB 4.8, the Bidder's qualifications to perform the contract if its Bid is accepted;

(g) Technical Proposal in accordance with ITB 16; and

(h) any other document **required in the BDS**.

11.2 In addition to the requirements under ITB 11.1, bids submitted by a JV shall include a copy of the Joint Venture Agreement entered into by all members. Alternatively, a letter of intent to execute a Joint Venture Agreement in the event of a successful bid shall be signed by all members and submitted with the bid, together with a copy of the proposed Agreement.

11.3 The Bidder shall furnish in the Letter of Bid information on commissions and gratuities, if any, paid or to be paid to agents or any other party relating to this Bid.

12. Letter of Bid and Schedules

12.1 The Letter of Bid and Schedules, including the Bill of Quantities, shall be prepared using the relevant forms furnished in Section IV, Bidding Forms. The forms must be completed without any alterations to the text, and no substitutes shall be accepted except as provided under ITB 20.2. All blank spaces shall be filled in with the information requested.

13. Alternative Bids

13.1 Unless otherwise **specified in the BDS**, alternative bids shall not be considered.

13.2 When alternative times for completion are explicitly invited, a statement to that effect **will be included in the BDS**, as will the method of evaluating different times for completion.

13.3 Except as provided under ITB 13.4 below, Bidders wishing to offer technical alternatives to the requirements of the Bidding Documents must first price the Employer's design as described in the Bidding Documents and shall further provide all information necessary for a complete evaluation of the alternative by the Employer, including drawings, design calculations, technical specifications, breakdown of prices, and proposed construction methodology and other relevant details. Only the technical alternatives, if any, of the lowest evaluated Bidder conforming to the basic technical requirements shall be considered by the Employer.

14. Bid Prices and Discounts

- 13.4 **When specified in the BDS**, Bidders are permitted to submit alternative technical solutions for specified parts of the Works. Such parts will be **identified in the BDS** and described in Section VII. Works Requirements. The method for their evaluation will be stipulated in Section III. Evaluation and Qualification Criteria.
- 14.1 The prices and discounts (including any price reduction) quoted by the Bidder in the Letter of Bid and in the Bill of Quantities shall conform to the requirements specified below.
- 14.2 The Bidder shall submit a bid for the whole of the works described in ITB 1.1 by filling in prices for all items of the Works, as identified in Section IV. Bidding Forms. In case of admeasurement contracts, the Bidder shall fill in rates and prices for all items of the Works described in the Bill of Quantities. Items against which no rate or price is entered by the Bidder will not be paid for by the Employer when executed and shall be deemed covered by the rates for other items and prices in the Bill of Quantities and will not be paid for separately by the Employer. An item not listed in the priced Bill of Quantities shall be assumed to be not included in the Bid, and provided that the Bid is determined substantially responsive notwithstanding this omission, the average price of the item quoted by substantially responsive bidders will be added to the bid price and the equivalent total cost of the bid so determined will be used for price comparison.
- 14.3 The price to be quoted in the Letter of Bid, in accordance with ITB 12.1, shall be the total price of the bid, excluding any discounts offered.
- 14.4 The Bidder shall quote any discounts and the methodology for their application in the Letter of Bid, in accordance with ITB 12.1.
- 14.5 **Unless otherwise provided in the BDS** and the Conditions of Contract, the rates and prices quoted by the Bidder are subject to adjustment during the performance of the Contract in accordance with the provisions of the Conditions of Contract, In such a case, the Bidder shall furnish the indices and weightings for the price adjustment formulae in the Schedule of Adjustment Data in Section IV- Bidding Forms and the Employer may require the Bidder to justify its proposed indices and weightings.
- 14.6 If so specified in ITB 1.1, bids are invited for individual lots (contracts) or for any combination of lots (packages). Bidders wishing to offer discounts for the award of more than one

Contract shall specify in their bid the price reductions applicable to each package, or alternatively, to individual Contracts within the package. Discounts shall be submitted in accordance with ITB 14.4, provided the bids for all lots (contracts) are opened at the same time.

- 14.7 All duties, taxes, and other levies payable by the Contractor under the Contract, or for any other cause, as of the date 28 days prior to the deadline for submission of bids, shall be included in the rates and prices¹ and the total bid price submitted by the Bidder.
- 15. Currencies of Bid and Payment**
- 15.1 The currency(ies) of the bid and the currency(ies) of payments shall be as **specified in the BDS**.
- 15.2 Bidders may be required by the Employer to justify, to the Employer's satisfaction, their local and foreign currency requirements, and to substantiate that the amounts included in the unit rates and prices and shown in the Schedule of Adjustment Data are reasonable², in which case a detailed breakdown of the foreign currency requirements shall be provided by Bidders.
- 16. Documents Comprising the Technical Proposal**
- 16.1 The Bidder shall furnish a Technical Proposal including a statement of work methods, equipment, personnel, schedule and any other information as stipulated in Section IV, Bidding Forms, in sufficient detail to demonstrate the adequacy of the Bidders' proposal to meet the work requirements and the completion time.
- 17. Documents Establishing the Qualifications of the Bidder**
- 17.1 In accordance with Section III, Evaluation and Qualification Criteria, to establish that the Bidder continues to meet the criteria used at the time of prequalification, the Bidder shall provide in the corresponding information sheets included in Section IV, Bidding Forms, updated information on any assessed aspect that changed from that time, or if post-qualification applies as specified in ITB 4.8, the Bidder shall provide the information requested in the corresponding information sheets included in Section IV, Bidding Forms.
- 17.2 If a margin of preference applies as specified in accordance with ITB 33.1, domestic Bidders, individually or in joint ventures, applying for eligibility for domestic preference shall supply all information required to satisfy the criteria for eligibility specified in accordance with ITB 33.1.

¹ In lump sum contracts, delete "rates and prices and the."

² For lump sum contracts, delete "unit rates and prices and shown in the Schedule of Adjustment Data are reasonable" and replace with "Lump Sum."

17.3 Any change in the structure or formation of a Bidder after being prequalified and invited to Bid (including, in the case of a JV, any change in the structure or formation of any member thereto) shall be subject to the written approval of the Employer prior to the deadline for submission of Bids. Such approval shall be denied if (i) a Bidder proposes to associate with a disqualified Bidder or in case of a disqualified joint venture, any of its members; (ii) as a consequence of the change, the Bidder no longer substantially meets the qualification criteria set forth in Section III, Qualification Criteria and Requirements; or (iii) in the opinion of the Employer, the change may result in a substantial reduction in competition. Any such change should be submitted to the Employer not later than fourteen (14) days after the date of the Invitation for Bids.

18. Period of Validity of Bids

18.1 Bids shall remain valid for the period **specified in the BDS** after the bid submission deadline date prescribed by the Employer in accordance with ITB 22.1. A bid valid for a shorter period shall be rejected by the Employer as nonresponsive.

18.2 In exceptional circumstances, prior to the expiration of the bid validity period, the Employer may request Bidders to extend the period of validity of their bids. The request and the responses shall be made in writing. If a bid security is requested in accordance with ITB 19, it shall also be extended for twenty-eight (28) days beyond the deadline of the extended validity period. A Bidder may refuse the request without forfeiting its bid security. A Bidder granting the request shall not be required or permitted to modify its bid, except as provided in ITB 18.3.

18.3 If the award is delayed by a period exceeding fifty-six (56) days beyond the expiry of the initial bid validity, the Contract price shall be determined as follows:

- (a) In the case of fixed price contracts, the Contract price shall be the bid price adjusted by the factor **specified in the BDS**.
- (b) In the case of adjustable price contracts, no adjustment shall be made.
- (c) In any case, bid evaluation shall be based on the bid price without taking into consideration the applicable correction from those indicated above.

19. Bid Security

19.1 The Bidder shall furnish as part of its bid, either a Bid-Securing Declaration or a bid security **as specified in the BDS**, in original form and, in the case of a bid security, in the amount and

currency **specified in the BDS.**

19.2 A Bid Securing Declaration shall use the form included in Section IV, Bidding Forms.

19.3 If a bid security is specified pursuant to ITB 19.1, the bid security shall be a demand guarantee in any of the following forms at the Bidder's option:

- (a) an unconditional guarantee issued by a bank or financial institution (such as an insurance, bonding or surety company);
- (b) an irrevocable letter of credit;
- (c) a cashier's or certified check; or
- (d) another security **specified in the BDS.**

from a reputable source from an eligible country. If the unconditional guarantee is issued by a financial institution located outside the Employer's Country, the issuing financial institution shall have a correspondent financial institution located in the Employer's Country to make it enforceable. In the case of a bank guarantee, the bid security shall be submitted either using the Bid Security Form included in Section IV, Bidding Forms, or in another substantially similar format approved by the Employer prior to bid submission. The bid security shall be valid for twenty-eight (28) days beyond the original validity period of the bid, or beyond any period of extension if requested under ITB 18.2.

19.4 If a bid security or Bid Securing Declaration is specified pursuant to ITB 19.1, any bid not accompanied by a substantially responsive bid security or Bid-Securing Declaration shall be rejected by the Employer as non responsive.

19.5 If a bid security is specified pursuant to ITB 19.1, the bid security of unsuccessful Bidders shall be returned as promptly as possible upon the successful Bidder's signing the Contract and furnishing the performance security pursuant to ITB 42.

19.6 The bid security of the successful Bidder shall be returned as promptly as possible once the successful Bidder has signed the Contract and furnished the required performance security.

19.7 The bid security may be forfeited or the Bid Securing Declaration executed:

- (a) if a Bidder withdraws its bid during the period of bid

validity specified by the Bidder on the Letter of Bid, , or any extension thereto provided by the Bidder; or

(b) if the successful Bidder fails to:

(i) sign the Contract in accordance with ITB 41; or

(ii) furnish a performance security in accordance with ITB 42.

19.8 The bid security or the Bid Securing Declaration of a JV shall be in the name of the JV that submits the bid. If the JV has not been constituted into a legally-enforceable JV, at the time of bidding, the Bid Security or the Bid Securing Declaration shall be in the names of all future members as named in the letter of intent mentioned in ITB 4.1 and ITB 11.2.

19.9 If a bid security is **not required in the BDS** pursuant to ITP 19.1, and

(a) if a Bidder withdraws its bid during the period of bid validity specified by the Bidder on the Letter of Bid, or

(b) if the successful Bidder fails to: sign the Contract in accordance with ITB 41; or furnish a performance security in accordance with ITB 42;

the Beneficiary may, **if provided for in the BDS**, declare the Bidder ineligible to be awarded a contract by the Employer for a period of time **as stated in the BDS**.

20. Format and Signing of Bid

20.1 The Bidder shall prepare one original of the documents comprising the bid as described in ITB 11 and clearly mark it "ORIGINAL". Alternative bids, if permitted in accordance with ITB 13, shall be clearly marked "ALTERNATIVE". In addition, the Bidder shall submit copies of the bid in the number **specified in the BDS**, and clearly mark each of them "COPY." In the event of any discrepancy between the original and the copies, the original shall prevail.

20.2 The original and all copies of the bid shall be typed or written in indelible ink and shall be signed by a person duly authorized to sign on behalf of the Bidder. This authorization shall consist of a written confirmation as **specified in the BDS** and shall be attached to the bid. The name and position held by each person signing the authorization must be typed or printed below the signature. All pages of the bid where entries or amendments have been made shall be signed or initialed by the person signing the

bid.

20.3 In case the Bidder is a JV, the Bid shall be signed by an authorized representative of the JV on behalf of the JV, and so as to be legally binding on all the members as evidenced by a power of attorney signed by their legally authorized representatives.

20.4 Any interlineations, erasures, or overwriting shall be valid only if they are signed or initialed by the person signing the bid.

D. Submission and Opening of Bids

21. Sealing and Marking of Bids

21.1 The Bidder shall enclose the original and all copies of the bid, including alternative bids, if permitted in accordance with ITB 13, in separate sealed envelopes, duly marking the envelopes as "ORIGINAL", "ALTERNATIVE" and "COPY." These envelopes containing the original and the copies shall then be enclosed in one single envelope.

21.2 The inner and outer envelopes shall:

- (a) bear the name and address of the Bidder;
- (b) be addressed to the Employer as **provided in the BDS** pursuant to ITB 22.1;
- (c) bear the specific identification of this bidding process specified in accordance with BDS 1.1; and
- (d) bear a warning not to open before the time and date for bid opening.

21.3 If all envelopes are not sealed and marked as required, the Employer will assume no responsibility for the misplacement or premature opening of the bid.

22. Deadline for Submission of Bids

22.1 Bids must be received by the Employer at the address and no later than the date and time **specified in the BDS**. When so **specified in the BDS**, bidders shall have the option of submitting their bids electronically. Bidders submitting bids electronically shall follow the electronic bid submission procedures **specified in the BDS**.

22.2 The Employer may, at its discretion, extend the deadline for the submission of bids by amending the Bidding Document in accordance with ITB 8, in which case all rights and obligations of the Employer and Bidders previously subject to the deadline shall thereafter be subject to the deadline as extended.

- 23. Late Bids**
- 23.1 The Employer shall not consider any bid that arrives after the deadline for submission of bids, in accordance with ITB 22. **Any bid received by the Employer after the deadline for submission of bids shall be declared late, rejected, and returned unopened to the Bidder.**
- 24. Withdrawal, Substitution, and Modification of Bids**
- 24.1 A Bidder may withdraw, substitute, or modify its bid after it has been submitted by sending a written notice, duly signed by an authorized representative, and shall include a copy of the authorization in accordance with ITB 20.2, (except that withdrawal notices do not require copies). The corresponding substitution or modification of the bid must accompany the respective written notice. All notices must be:
- (a) prepared and submitted in accordance with ITB 20 and ITB 21 (except that withdrawal notices do not require copies), and in addition, the respective envelopes shall be clearly marked “WITHDRAWAL,” “SUBSTITUTION,” “MODIFICATION;” and
 - (b) received by the Employer prior to the deadline prescribed for submission of bids, in accordance with ITB 22.
- 24.2 Bids requested to be withdrawn in accordance with ITB 24.1 shall be returned unopened to the Bidders.
- 24.3 No bid may be withdrawn, substituted, or modified in the interval between the deadline for submission of bids and the expiration of the period of bid validity specified by the Bidder on the Letter of Bid or any extension thereof.
- 25. Bid Opening**
- 25.1 Except in the cases specified in ITB 23 and 24, the Employer shall publicly open and read out in accordance with ITB 25.3 all bids received by the deadline, at the date, time and place **specified in the BDS**, in the presence of Bidders` designated representatives and anyone who choose to attend. Any specific electronic bid opening procedures required if electronic bidding is permitted in accordance with ITB 22.1, shall be **as specified in the BDS**.
- 25.2 First, envelopes marked “WITHDRAWAL” shall be opened and read out and the envelope with the corresponding bid shall not be opened, but returned to the Bidder. No bid withdrawal shall be permitted unless the corresponding withdrawal notice contains a valid authorization to request the withdrawal and is read out at bid opening. Next, envelopes marked “SUBSTITUTION” shall be opened and read out and exchanged with the corresponding bid being substituted, and the substituted bid shall not be opened, but returned to the Bidder. No bid substitution shall be permitted

unless the corresponding substitution notice contains a valid authorization to request the substitution and is read out at bid opening. Envelopes marked "MODIFICATION" shall be opened and read out with the corresponding bid. No bid modification shall be permitted unless the corresponding modification notice contains a valid authorization to request the modification and is read out at bid opening. Only envelopes that are opened and read out at bid opening shall be considered further.

- 25.3 All other envelopes shall be opened one at a time, reading out: the name of the Bidder and whether there is a modification; the total Bid Price, per lot (contract) if applicable, including any discounts and alternative bids; the presence or absence of a bid security, or Bid Securing Declaration, if required; and any other details as the Employer may consider appropriate. Only discounts and alternative bids read out at bid opening shall be considered for evaluation. The Letter of Bid and the Bill of Quantities are to be initialed by representatives of the Employer attending bid opening in the manner **specified in the BDS**. The Employer shall neither discuss the merits of any bid nor reject any bid (except for late bids, in accordance with ITB 23.1).
- 25.4 The Employer shall prepare a record of the bid opening that shall include, as a minimum: the name of the Bidder and whether there is a withdrawal, substitution, or modification; the Bid Price, per lot (contract) if applicable, including any discounts and alternative bids; and the presence or absence of a bid security, if one was required. The Bidders' representatives who are present shall be requested to sign the record. The omission of a Bidder's signature on the record shall not invalidate the contents and effect of the record. A copy of the record shall be distributed to all Bidders.

E. Evaluation and Comparison of Bids

- 26. Confidentiality**
- 26.1 Information relating to the evaluation of bids and recommendation of contract award, shall not be disclosed to Bidders or any other persons not officially concerned with the bidding process until information on Contract award is communicated to all Bidders in accordance with ITB 40.
- 26.2 Any attempt by a Bidder to influence the Employer in the evaluation of the bids or Contract award decisions may result in the rejection of its bid.
- 26.3 Notwithstanding ITB 26.2, from the time of bid opening to the time of Contract award, if a Bidder wishes to contact the Employer on any matter related to the bidding process, it shall do

so in writing.

27. Clarification of Bids

27.1 To assist in the examination, evaluation, and comparison of the bids, and qualification of the Bidders, the Employer may, at its discretion, ask any Bidder for a clarification of its bid given a reasonable time for a response. Any clarification submitted by a Bidder that is not in response to a request by the Employer shall not be considered. The Employer's request for clarification and the response shall be in writing. No change, including any voluntary increase or decrease in the prices or substance of the bid shall be sought, offered, or permitted, except to confirm the correction of arithmetic errors discovered by the Employer in the evaluation of the bids, in accordance with ITB 31.

27.2 If a Bidder does not provide clarifications of its bid by the date and time set in the Employer's request for clarification, its bid may be rejected.

28. Deviations, Reservations, and Omissions

28.1 During the evaluation of bids, the following definitions apply:

- (a) "Deviation" is a departure from the requirements specified in the Bidding Document;
- (b) "Reservation" is the setting of limiting conditions or withholding from complete acceptance of the requirements specified in the Bidding Document; and
- (c) "Omission" is the failure to submit part or all of the information or documentation required in the Bidding Document.

29. Determination of Responsiveness

29.1 The Employer's determination of a bid's responsiveness is to be based on the contents of the bid itself, as defined in ITB11.

29.2 A substantially responsive bid is one that meets the requirements of the Bidding Document without material deviation, reservation, or omission. A material deviation, reservation, or omission is one that,

- (a) if accepted, would:
 - (i) affect in any substantial way the scope, quality, or performance of the Works specified in the Contract; or
 - (ii) limit in any substantial way, inconsistent with the Bidding Document, the Employer's rights or the Bidder's obligations under the proposed Contract; or
- (b) if rectified, would unfairly affect the competitive position of

other Bidders presenting substantially responsive bids.

29.3 The Employer shall examine the technical aspects of the bid submitted in accordance with ITB 16, Technical Proposal, in particular, to confirm that all requirements of Section VII (Works Requirements) have been met without any material deviation, reservation or omission.

29.4 If a bid is not substantially responsive to the requirements of the Bidding Document, it shall be rejected by the Employer and may not subsequently be made responsive by correction of the material deviation, reservation, or omission.

30. Nonconformities, Errors, and Omissions

30.1 Provided that a bid is substantially responsive, the Employer may waive any nonconformities in the bid.

30.2 Provided that a bid is substantially responsive, the Employer may request that the Bidder submit the necessary information or documentation, within a reasonable period of time, to rectify nonmaterial nonconformities in the bid related to documentation requirements. Requesting information or documentation on such nonconformities shall not be related to any aspect of the price of the Bid. Failure of the Bidder to comply with the request may result in the rejection of its Bid.

30.3 Provided that a bid is substantially responsive, the Employer shall rectify quantifiable nonmaterial nonconformities related to the Bid Price. To this effect, the Bid Price may be adjusted, for comparison purposes only, to reflect the price of a missing or non-conforming item or component. The adjustment shall be made using the methods specified in Section III (Evaluation and Qualification Criteria).

31. Correction of Arithmetical Errors

31.1 Provided that the bid is substantially responsive, the Employer shall correct arithmetical errors on the following basis:

- (a) if there is a discrepancy between the unit price and the total price that is obtained by multiplying the unit price and quantity, the unit price shall prevail and the total price shall be corrected, unless in the opinion of the Employer there is an obvious misplacement of the decimal point in the unit price, in which case the total price as quoted shall govern and the unit price shall be corrected;
- (b) if there is an error in a total corresponding to the addition or subtraction of subtotals, the subtotals shall prevail and the total shall be corrected; and

- (c) if there is a discrepancy between words and figures, the amount in words shall prevail, unless the amount expressed in words is related to an arithmetic error, in which case the amount in figures shall prevail subject to (a) and (b) above.
- 31.2 Bidders shall be requested to accept correction of arithmetical errors. Failure to accept the correction in accordance with ITB 31.1, shall result in the rejection of the Bid.
- 32. Conversion to Single Currency** 32.1 For evaluation and comparison purposes, the currency(ies) of the Bid shall be converted into a single currency as **specified in the BDS**.
- 33. Margin of Preference** 33.1 **Unless otherwise specified in the BDS**, a margin of preference for domestic bidders³ shall not apply.
- 34. Subcontractors** 34.1 **Unless otherwise stated in the BDS**, the Employer does not intend to execute any specific elements of the Works by subcontractors selected in advance by the Employer.
- 34.2 In case of Prequalification, the Bidder's Bid shall name the same specialized subcontractor as submitted in the prequalification application and approved by the Employer.
- 34.3 In case of Post qualification, the Employer may permit subcontracting for certain specialized works as indicated in Section III 4.2. When subcontracting is permitted by the Employer, the specialized sub-contractor's experience shall be considered for evaluation. Section III describes the qualification criteria for sub-contractors.
- 34.4 Bidders may propose subcontracting up to the percentage of total value of contracts or the volume of works as **specified in the BDS**.
- 35. Evaluation of Bids** 35.1 The Employer shall use the criteria and methodologies listed in this Clause. No other evaluation criteria or methodologies shall be permitted.

³ An individual firm is considered a domestic bidder for purposes of the margin of preference if it is registered in the country of the Employer, has more than 50 percent ownership by nationals of the country of the Employer, and if it does not subcontract more than 10 percent of the contract price, excluding provisional sums, to foreign contractors. JVs are considered as domestic bidders and eligible for domestic preference only if the individual member firms are registered in the country of the Employer or have more than 50 percent ownership by nationals of the country of the Employer, and the JV shall be registered in the country of the Beneficiary. The JV shall not subcontract more than 10 percent of the contract price, excluding provisional sums, to foreign firms. JVs between foreign and national firms will not be eligible for domestic preference.

35.2 To evaluate a bid, the Employer shall consider the following:

- (a) the bid price, excluding Provisional Sums and the provision, if any, for contingencies in the Summary Bill of Quantities⁴, but including Daywork⁵ items, where priced competitively;
- (b) price adjustment for correction of arithmetic errors in accordance with ITB 31.1;
- (c) price adjustment due to discounts offered in accordance with ITB 14.4;
- (d) converting the amount resulting from applying (a) to (c) above, if relevant, to a single currency in accordance with ITB 32;
- (e) price adjustment due to quantifiable nonmaterial nonconformities in accordance with ITB 30.3;
- (f) the additional evaluation factors are specified in Section III (Evaluation and Qualification Criteria);

35.3 The estimated effect of the price adjustment provisions of the Conditions of Contract, applied over the period of execution of the Contract, shall not be taken into account in bid evaluation.

35.4 If this Bidding Document allows Bidders to quote separate prices for different lots (contracts), the methodology to determine the lowest evaluated price of the contract combinations, including any discounts offered in the Letter of Bid, is specified in Section III. Evaluation and Qualification Criteria.

35.5 If the bid, which results in the lowest Evaluated Bid Price, is seriously unbalanced or, front loaded in the opinion of the Employer, the Employer may require the Bidder to produce detailed price analyses for any or all items of the Bill of Quantities, to demonstrate the internal consistency of those prices with the construction methods and schedule proposed. After evaluation of the price analyses, taking into consideration the schedule of estimated Contract payments, the Employer may require that the amount of the performance security be increased at the expense of the Bidder to a level sufficient to protect the Employer against financial loss in the event of default of the

⁴ In lump sum contracts, delete “Bill of Quantities” and replace with “Activity Schedule.”

⁵ Daywork is work carried out following instructions of the Project Manager and paid for on the basis of time spent by workers, and the use of materials and the Contractor’s equipment, at the rates quoted in the Bid. For Daywork to be priced competitively for Bid evaluation purposes, the Employer must list tentative quantities for individual items to be costed against Daywork (e.g., a specific number of tractor driver staff-days, or a specific tonnage of Portland cement), to be multiplied by the bidders’ quoted rates and included in the total Bid price.

successful Bidder under the Contract.

- 36. Comparison of Bids** 36.1 The Employer shall compare the evaluated prices of all substantially responsive bids established in accordance with ITB 35.2 to determine the lowest evaluated bid.
- 37. Qualification of the Bidder** 37.1 The Employer shall determine to its satisfaction whether the Bidder that is selected as having submitted the lowest evaluated and substantially responsive bid either continues to meet (if prequalification applies) or meets (if post qualification applies) the qualifying criteria specified in Section III. Evaluation and Qualification Criteria.
- 37.2 The determination shall be based upon an examination of the documentary evidence of the Bidder's qualifications submitted by the Bidder, pursuant to ITB 17.1.
- 37.3 An affirmative determination of qualification shall be a prerequisite for award of the Contract to the Bidder. A negative determination shall result in disqualification of the bid, in which event the Employer shall proceed to the next lowest evaluated bid to make a similar determination of that Bidder's qualifications to perform satisfactorily.
- 38. Employer's Right to Accept Any Bid, and to Reject Any or All Bids** 38.1 The Employer reserves the right to accept or reject any bid, and to annul the bidding process and reject all bids at any time prior to contract award, without thereby incurring any liability to Bidders. In case of annulment, all bids submitted and specifically, bid securities, shall be promptly returned to the Bidders.

F. Award of Contract

- 39. Award Criteria** 39.1 Subject to ITB 37.1, the Employer shall award the Contract to the Bidder whose bid has been determined to be the lowest evaluated bid and is substantially responsive to the Bidding Document, provided further that the Bidder is determined to be qualified to perform the Contract satisfactorily.
- 40. Notification of Award** 40.1 Prior to the expiration of the period of bid validity, the Employer shall notify the successful Bidder, in writing, that its bid has been accepted. The notification letter (hereinafter and in the Conditions of Contract and Contract Forms called the "Letter of Acceptance") shall specify the sum that the Employer will pay the Contractor in consideration of the execution and completion of the Works (hereinafter and in the Conditions of Contract and Contract Forms called "the Contract Price"). At the same time,

the Employer shall also notify all other Bidders of the results of the bidding and shall publish in an appropriate newspaper or Gazette and OFID website online the results identifying the bid and lot (contract) numbers and the following information:

- (i) name of each Bidder who submitted a Bid;
- (ii) bid prices as read out at Bid Opening;
- (iii) name and evaluated prices of each Bid that was evaluated;
- (iv) name of bidders whose bids were rejected and the reasons for their rejection; and
- (v) name of the successful Bidder, and the Price it offered, as well as the duration and summary scope of the contract awarded.

40.2 Until a formal contract is prepared and executed, the notification of award shall constitute a binding Contract.

40.3 The Employer shall promptly respond in writing to any unsuccessful Bidder who, after notification of award in accordance with ITB 40.1, requests in writing the grounds on which its bid was not selected.

41. Signing of Contract

41.1 Promptly upon notification, the Employer shall send the successful Bidder the Contract Agreement.

41.2 Within twenty-eight (28) days of receipt of the Contract Agreement, the successful Bidder shall sign, date, and return it to the Employer.

42. Performance Security

42.1 Within twenty-eight (28) days of the receipt of notification of award from the Employer, the successful Bidder shall furnish the performance security in accordance with the General Conditions of Contract, subject to ITB 35.5, using for that purpose the Performance Security Form included in Section X. Contract Forms, or another form acceptable to the Employer. If the performance security furnished by the successful Bidder is in the form of a bond, it shall be issued by a bonding or insurance company that has been determined by the successful Bidder to be acceptable to the Employer. A foreign institution providing a bond shall have a correspondent financial institution located in the Employer's Country.

42.2 Failure of the successful Bidder to submit the above-mentioned Performance Security or to sign the Contract Agreement shall constitute sufficient grounds for the annulment of the award and forfeiture of the bid security. In that event the Employer may award the Contract to the next lowest evaluated Bidder whose offer is substantially responsive and is determined by the Employer to be qualified to perform the Contract satisfactorily.

Section II - Bid Data Sheet (BDS)

A. Introduction

ITB 1.1	The number of the Invitation for Bids is : (IUL)438/1/2017/16 The Employer is: <i>Ministry of Environment and Energy</i>
ITB 1.1	The name of the bidding process is: <i>Construction of Island Waste Management Centre (IWMC) at H.Dh.Kumundhoo</i> The identification number of the bidding process is: <i>OFIDPMU/2017/PH2-003</i> The number and identification of lots comprising this bidding process is: <i>NA</i>
ITB 2.1	The Beneficiary is: <i>The Government of Maldives</i>
ITB 2.1	The name of the Project is: <i>Provision of Water Supply, Sanitation and Solid Waste Management Project</i>
ITB 2.1	Loan or Financing Agreement amount: <i>USD....</i>
ITB 4.1	Maximum number of members in the JV shall be: <i>N/A</i>
ITB 4.4	The electronic address of firms and individuals debarred by the Fund is available at: http://www.ofid.org
ITB 4.8	This Bidding Process IS NOT subjected to prequalification.

B. Bidding Documents

ITB 7.1	For <u>clarification purposes</u> only, the Employer's address is: Attention: <i>OFID Project Management Unit,</i> <i>Ministry of Environment and Energy</i> <i>Green Building, Handhuvaree Hingun,</i> <i>Republic of Maldives,</i> <i>Tel: (+960) 3018 453, (+960) 3018 454</i> <i>Email: ofid.pmu@environment.gov.mv</i>
ITB 7.1	Web page: www.environment.gov.mv

ITB 7.4	<p>A Pre-Bid meeting <i>shall</i> take place at the following date, time and place:</p> <p>Date: 22nd March 2017</p> <p>Time: 1000hrs</p> <p>Place: Ministry of Environment and Energy Green Building, Handhuvarree Hingun, Republic of Maldives,</p>
----------------	---

C. Preparation of Bids

ITB 10.1	<p>The language of the bid is: English</p> <p>All correspondence exchange shall be in English language.</p> <p>Language for translation of supporting documents and printed literature is English</p>
ITB 13.1	Alternative bids <i>shall not be</i> permitted.
ITB 13.2	<p>Alternative times for completion <i>shall not be</i> permitted.</p> <p>If alternative times for completion are permitted, the evaluation method will be as specified in Section III, Evaluation and Qualification Criteria.</p>
ITB 14.5	N/A
ITB 15.1	The currency(ies) of the bid and the payment currency(ies) shall be in Maldivian Rufiyaa (MVR) .
ITB 18.1	The bid validity period shall be: 90 days.
ITB 19.1	<p>A Bid Security <i>shall be</i> required.</p> <p>The amount and currency of the bid security shall be: MVR 10,000</p>
ITB 19.3 (d)	Bid Security Shall be an unconditional guarantee issued by a bank or financial institution (such as an insurance, bonding or surety company).
ITB 19.9	N/A
ITB 20.1	In addition to the original of the bid, the number of copies is: 1 No.
ITB 20.2	The written confirmation of authorization to sign on behalf of the Bidder shall consist of: Power of Attorney

D. Submission and Opening of Bids

ITB 22.1	<p>For <u>bid submission purposes</u> only, the Employer's address is:</p> <p>Attention: <i>OFID Project Management Unit,</i></p> <p style="text-align: center;"><i>Ministry of Environment and Energy</i> <i>Green Building, Handhuvaree Hingun,</i> <i>Republic of Maldives,</i> <i>Tel: (+960) 3018 453, (+960) 3018 454</i> <i>Email: ofid.pmu@environment.gov.mv</i></p> <p>The deadline for bid submission is:</p> <p>Date: <i>12th April 2017</i></p> <p>Time: <i>1300hrs</i></p> <p>Bidders <i>shall not</i> have the option of submitting their bids electronically.</p> <p>If bidders have the option of submitting their bids electronically, the electronic bidding submission procedures shall be: <i>N/A</i></p>
ITB 25.1	<p>The bid opening shall take place at:</p> <p><i>OFID Project Management Unit,</i></p> <p style="text-align: center;"><i>Ministry of Environment and Energy</i> <i>Green Building, Handhuvaree Hingun,</i> <i>Republic of Maldives,</i> <i>Tel: (+960) 3018 453, (+960) 3018 454</i> <i>Email: ofid.pmu@environment.gov.mv</i></p> <p>Date: <i>12th April 2017</i></p> <p>Time: <i>1300hrs</i></p>

E. Evaluation and Comparison of Bids

ITB 32.1	<p>The currency that shall be used for bid evaluation and comparison purposes to convert all bid prices expressed in various currencies into a single currency is: <i>United States Dollars (USD)</i></p> <p>The source of exchange rate shall be: <i>Maldives Monetary Authority (MMA)</i></p> <p>The date for the exchange rate shall be: <i>14 days before Bid Submission deadline.</i></p> <p><i>The currency(ies) of the Bid shall be converted into a single currency in accordance with the procedure under Alternative B that follows:</i></p>
-----------------	---

	<p>Alternative A: Bidders quote entirely in local currency</p> <p><i>For comparison of bids, the Bid Price, corrected pursuant to Clause 31, shall first be broken down into the respective amounts payable in various currencies by using the exchange rates specified by the bidder in accordance with Sub-Clause 15.1.</i></p> <p><i>In the second step, the Employer will convert the amounts in various currencies in which the Bid Price is payable (excluding Provisional Sums but including Daywork where priced competitively) to the single currency identified above at the selling rates established for similar transactions by the authority specified and on the date stipulated above.</i></p> <p>OR</p> <p>Alternative B: Bidders quote in local and foreign currencies</p> <p><i>The Employer will convert the amounts in various currencies in which the Bid Price, corrected pursuant to Clause 31, is payable (excluding Provisional Sums but including Daywork where priced competitively) to the single currency identified above at the selling rates established for similar transactions by the authority specified and on the date stipulated above.</i></p>
ITB 33.1	A margin of preference shall not apply.
ITB 34.1	At this time the Employer does not intend to execute certain specific parts of the Works by sub-contractors selected in advance.
ITB 34.3	<p>Option 1:</p> <p>a) In the case of Prequalification: N/A</p> <p>Option 2:</p> <p>a) In the case of Post qualification:</p> <p>Contractor's proposed subcontracting: Maximum percentage of subcontracting permitted is: 30% of the total contract amount.</p> <p>b) Bidders planning to subcontract more than 10% of total volume of work shall specify, in the Letter of Bid, the activity (ies) or parts of the works to be subcontracted along with complete details of the sub-contractors and their qualification and experience. The qualification and experience of the sub-contractors must meet the minimum criteria for the relevant work to be subcontracted failing which such sub-contractors will not be permitted to participate.</p> <p>c) Sub-contractors' qualification and experience will not be considered for evaluation of the Bidder. The Bidder on its own (without taking into account the qualification and experience of the sub-contractor) should meet the qualification criteria.</p>

Section III - Evaluation and Qualification Criteria (Without Prequalification)

This section contains all the criteria that the Employer shall use to evaluate bids and qualify Bidders. In accordance with ITB 35 and ITB 37, no other methods, criteria and factors shall be used. The Bidder shall provide all the information requested in the forms included in Section IV (Bidding Forms).

Wherever a Bidder is required to state a monetary amount, Bidders should indicate the USD equivalent in Maldivian Rufiyaa (MVR) using the rate of exchange determined as follows:

- -For construction turnover or financial data required for each year - Exchange rate prevailing on the last day of the respective calendar year (in which the amounts for that year is to be converted) was originally established.
- -Value of single contract - Exchange rate prevailing on the date of the contract.

Exchange rates shall be taken from the publicly available source identified in the ITB 32.1. Any error in determining the exchange rates in the Bid may be corrected by the Employer

Table of Criteria

1.	Margin of Preference.....	1-37
2.	Evaluation	1-37
2.1	Adequacy of Technical Proposal.....	1-37
2.2	Multiple Contracts	1-37
2.3	Alternative Completion Times	1-37
2.4	Technical Alternatives	1-38
2.5	Specialized Subcontractors	1-38
2.6	Quantifiable Nonconformities and Omissions	1-38
3.	Qualification	39
3.1	Eligibility	Error! Bookmark not defined.
3.2	Historical Contract Non Performance	Error! Bookmark not defined.
3.3	Financial Situation.....	Error! Bookmark not defined.
3.4	Experience.....	Error! Bookmark not defined.
3.5	Personnel.....	Error! Bookmark not defined.
3.6	Equipment	Error! Bookmark not defined.

1. Margin of Preference

N/A

2. Evaluation

In addition to the criteria listed in ITB 35.2 (a) – (e) the following criteria shall apply:

2.1 Adequacy of Technical Proposal

Evaluation of the Bidder's Technical Proposal will include an assessment of the Bidder's technical capacity to mobilize key equipment and personnel for the contract consistent with its proposal regarding work methods, scheduling, and material sourcing in sufficient detail and fully in accordance with the requirements stipulated in Section VII (Works Requirements).

Omission of information on non-significant equipment and personnel requirements described in Section V (Employer's Requirements) shall not be a ground for bid rejection and such non-compliance will be subject to clarification during bid evaluation and rectification prior to contract award.

2.2 Multiple Contracts

Works are grouped in multiple contracts and pursuant to ITB 34.4, the Employer shall evaluate and compare Bids on the basis of a contract, or a combination of contracts, or as a total of contracts in order to arrive at the least-cost combination for the Employer by taking into account discounts offered by Bidders in case of award of multiple contracts.

If a Bidder submits several successful (lowest evaluated substantially responsive) bids, the evaluation will also include an assessment of the Bidder's capacity to meet the following aggregated requirements as presented in the bid:

- Average annual construction turnover and,
- Financial resources,

2.3 Alternative Completion Times

An alternative Completion Time, if permitted under ITB 13.2, will be evaluated as follows: Not Applicable

2.4 Technical Alternatives

Technical alternatives, if permitted under ITB 13.4, will be evaluated as follows: *Not Applicable*

2.5 Specialized Subcontractors

Only the specific experience of sub-contractors for specialized works permitted by the Employer will be considered. The general experience and financial resources of the specialized sub-contractors shall not be added to those of the Bidder for purposes of qualification of the Bidder.

The specialized sub-contractors proposed shall be fully qualified for their work proposed, and meet the following criteria:

2.6 Quantifiable Nonconformities and Omissions

Subject to ITB 14.2 and ITB 34.2, the evaluated cost of quantifiable nonconformities including omissions, is determined as follows:

“Pursuant to ITB 30.3, the cost of all quantifiable nonmaterial nonconformities shall be evaluated, including omissions in Daywork where competitively priced but excluding omission of prices in the Bill of Quantities. The Employer will make its own assessment of the cost of any nonmaterial nonconformities and omissions for the purpose of ensuring fair comparison of Bids.”]

3. Qualification

Eligibility and Qualification Criteria		Compliance Requirements	Documentation
No.	Subject	Requirement	Submission Requirements
1. Eligibility			
1.1	Nationality	Nationality in accordance with ITB 4.3	Must meet requirement Forms ELI – 1.1 and 1.2, with attachments
1.2	Conflict of Interest	No conflicts of interest in accordance with ITB 4.2	Must meet requirement Letter of Bid
1.3	Fund Eligibility	Not having been declared ineligible by the Fund, as described in ITB 4.4, 4.5, 4.6 and 4.7	Must meet requirement Letter of Bid
1.4	Government Owned Entity of the Beneficiary country	Meets conditions of ITB 4.5	Must meet requirement Forms ELI – 1.1 and 1.2, with attachments
1.5	United Nations resolution or Beneficiary's country law or Boycott Regulation of OFID	Not having been excluded as a result of prohibition in the Beneficiary's country laws or official regulations against commercial relations with the Bidder's country, in accordance with ITB 4.7 and Section V.	Must meet requirement Forms ELI – 1.1 and 1.2, with attachments

Eligibility and Qualification Criteria		Compliance Requirements	Documentation
No.	Subject	Requirement	Single Entity
			Submission Requirements
2. Historical Contract Non-Performance			
2.1	History of Non-Performing Contracts	Non-performance of a contract ⁶ did not occur as a result of contractor default since <i>the last three (03) years</i>	Must meet requirement
2.2	Suspension Based on Execution of Bid Securing Declaration by the Employer or withdrawal of the Bid within Bid validity	Not under suspension based on execution of a Bid Securing Declaration pursuant to ITB 4.6 or withdrawal of the Bid pursuant ITB 19.9.	Must meet requirement
2.3	Pending Litigation	Bidder's financial position and prospective long term profitability sound according to criteria established in 3.1 below and assuming that all pending litigation will be resolved against the Bidder	Must meet requirement

⁶ Non performance, as decided by the Employer, shall include all contracts where (a) non performance was not challenged by the contractor, including through referral to the dispute resolution mechanism under the respective contract, and (b) contracts that were so challenged but fully settled against the contractor. Non performance shall not include contracts where Employers decision was overruled by the dispute resolution mechanism. Non performance must be based on all information on fully settled disputes or litigation, i.e. dispute or litigation that has been resolved in accordance with the dispute resolution mechanism under the respective contract and where all appeal instances available to the Bidder have been exhausted.

Eligibility and Qualification Criteria		Compliance Requirements	Documentation
No.	Subject	Requirement	Single Entity
			Submission Requirements
2.4	Litigation History	No consistent history of court/arbitral award decisions against the Bidder ⁷ since <i>the last five (05) years</i> .	Must meet requirement

⁷ The Bidder shall provide accurate information on the letter of Bid about any litigation or arbitration resulting from contracts completed or ongoing under its execution over the last five years. A consistent history of court/arbitral awards against the Bidder or any member of a joint venture may result in disqualifying the Bidder.

Eligibility and Qualification Criteria		Compliance Requirements	Documentation
No.	Subject	Requirement	Single Entity
		Submission Requirements	
3. Financial Situation and Performance			
3.1	Financial Capabilities	<p>(i) The Bidder shall demonstrate that it has access to, or has available, liquid assets, unencumbered real assets, lines of credit, and other financial means (independent of any contractual advance payment) sufficient to meet the construction cash flow requirements estimated as MVR 500,000 for the subject contract(s) net of the Bidders other commitments</p> <p>(ii) The Bidders shall also demonstrate, to the satisfaction of the Employer, that it has adequate sources of finance to meet the cash flow requirements on works currently in progress and for future contract commitments.</p> <p>(iii) The audited balance sheets or, if not required by the laws of the Bidder's country, other financial statements acceptable to the Employer, for the last three (03) years shall be submitted and must demonstrate the current soundness of the Bidder's financial position and indicate its prospective long-term profitability.</p>	<p>Must meet requirement</p> <p>Must meet requirement</p>
3.2	Average Annual Construction Turnover	Minimum average annual construction turnover of MVR 2,000,000 calculated as total certified payments received for contracts in progress and/or completed within the last three (03) years , divided by three (03) years	<p>Must meet requirement</p> <p>Must meet requirement</p>

Eligibility and Qualification Criteria		Compliance Requirements	Documentation
No.	Subject	Requirement	Single Entity
			Submission Requirements
4. Experience			
4.1 (a)	General Construction Experience	Experience under construction contracts in the role of prime contractor, JV member, sub-contractor, or management contractor for at least the last three (03) years	Must meet requirement
4.2 (a)	Specific Construction & Contract Management Experience	(i) A minimum number of similar ⁹ contracts specified below that have been satisfactorily and substantially ¹⁰ completed as a prime contractor, joint venture member ¹¹ , management contractor or sub-contractor ¹¹ between <i>the last three (03) years</i> and application submission deadline: (i) 2 contracts , each of minimum value MVR 1,000,000 ; Or (ii) Less than or equal to 5 contracts , each of minimum value MVR 400,000	Must meet requirements
			Must meet requirement ⁸

⁸ In the case of JV, the value of contracts completed by its members shall not be aggregated to determine whether the requirement of the minimum value of a single contract has been met. Instead, each contract performed by each member shall satisfy the minimum value of a single contract as required for single entity. In determining whether the JV meets the requirement of total number of contracts, only the number of contracts completed by all members each of value equal or more than the minimum value required shall be aggregated.

⁹ The similarity shall be based on the physical size, complexity, methods/technology and/or other characteristics described in Section VII, Work’s Requirements. Summation of number of small value contracts (less than the value specified under requirement) to meet the overall requirement will not be accepted.

¹⁰ Substantial completion shall be based on 80% or more works completed under the contract.

¹¹ For contracts under which the Bidder participated as a joint venture member or sub-contractor, only the Bidder’s share, by value, shall be considered to meet this requirement.

Section IV - Bidding Forms

Table of Forms

Letter of Bid	46
Schedules	49
Bill of Quantities	49
Schedule(s) of Adjustment Data	59
Form of Bid Security (Bank Guarantee)	60
Form of Bid Security (Bid Bond).....	Error! Bookmark not defined.
Form of Bid-Securing Declaration	Error! Bookmark not defined.
Technical Proposal.....	62
Technical Proposal Forms	62
Forms for Personnel	Error! Bookmark not defined.
Forms for Equipment.....	Error! Bookmark not defined.
Bidder's Qualification.....	63
Bidder Information Form.....	64
Information Form for JV Bidders	Error! Bookmark not defined.
Historical Contract Non-Performance, Pending Litigation and Litigation History	65
Current Contract Commitments / Works in Progress.....	66
Financial Situation and Performance	67
Average Annual Construction Turnover	69
Financial Resources.....	70
General Construction Experience	71
Specific Construction and Contract Management Experience	72
Construction Experience in Key Activities	Error! Bookmark not defined.

Letter of Bid

The Bidder must prepare the Letter of Bid on stationery with its letterhead clearly showing the Bidder's complete name and address.

Note: All italicized text is for use in preparing these form and shall be deleted from the final products.

Date: *[insert date (as day, month and year) of Bid Submission]*

ICB No.: *[insert number of bidding process]*

Invitation for Bid No.: *[insert identification]*

To: *[insert complete name of Employer]*

We, the undersigned, declare that:

- (a) We have examined and have no reservations to the Bidding Documents, including Addenda issued in accordance with Instructions to Bidders (ITB 8)_____;
- (b) We meet the eligibility requirements and have no conflict of interest in accordance with ITB 4;
- (c) We have not been suspended nor declared ineligible by the Employer based on execution of a Bid Securing Declaration in the Employer's country in accordance with ITB 4.6
- (d) We offer to execute in conformity with the Bidding Documents the following Works: *[insert a brief description of the Works]*;
- (e) The total price of our Bid, excluding any discounts offered in item (f) below is:

In case of only one lot, total price of the Bid *[insert the total price of the bid in words and figures, indicating the various amounts and the respective currencies]*;

In case of multiple lots, total price of each lot [insert the total price of each lot in words and figures, indicating the various amounts and the respective currencies];

In case of multiple lots, total price of all lots (sum of all lots) [insert the total price of all lots in words and figures, indicating the various amounts and the respective currencies];

- (f) The discounts offered and the methodology for their application are:

- (i) The discounts offered are: *[Specify in detail each discount offered.]*

- (ii) The exact method of calculations to determine the net price after application of discounts is shown below: ***[Specify in detail the method that shall be used to apply the discounts]***;
- (g) Our bid shall be valid for a period of ***[specify the number of calendar days]*** days from the date fixed for the bid submission deadline in accordance with the Bidding Documents, and it shall remain binding upon us and may be accepted at any time before the expiration of that period;
- (h) If our bid is accepted, we commit to obtain a performance security in accordance with the Bidding Documents;
- (i) We are not participating, as a Bidder or as a subcontractor, in more than one bid in this bidding process in accordance with ITB 4.2(e), other than alternative bids submitted in accordance with ITB 13;
- (j) We, including any of our subcontractors or suppliers for any part of the contract, have not been declared ineligible by the Fund, under the Employer’s country laws or official regulations or by an act of compliance with a decision of the OFID;
- (k) We are not a government owned entity/ We are a government owned entity but meet the requirements of ITB 4.5;¹²
- (l) We have paid, or will pay the following commissions, gratuities, or fees with respect to the bidding process or execution of the Contract: ***[insert complete name of each Recipient, its full address, the reason for which each commission or gratuity was paid and the amount and currency of each such commission or gratuity]***

Name of Recipient	Address	Reason	Amount
_____	_____	_____	_____
_____	_____	_____	_____
_____	_____	_____	_____
_____	_____	_____	_____

(If none has been paid or is to be paid, indicate “none.”)

- (m) We understand that this bid, together with your written acceptance thereof included in your notification of award, shall constitute a binding contract between us, until a formal contract is prepared and executed; and
- (n) We understand that you are not bound to accept the lowest evaluated bid or any other bid that you may receive.
- (o) We agree to permit OFID or its representative to inspect our accounts and records and other documents relating to the bid submission and to have them audited by auditors appointed by OFID.

¹² Bidder to use as appropriate

- (p) If our Bid is accepted, we commit to mobilizing key equipment and personnel in accordance with the requirements set forth in Section V (Employer's Requirements) and our technical proposal, or as otherwise agreed with the Employer.
- (q) We hereby certify that we have taken steps to ensure that no person acting for us or on our behalf will engage in any type of fraud and corruption

Name of the Bidder* *[insert complete name of person signing the Bid]*

Name of the person duly authorized to sign the Bid on behalf of the Bidder** *[insert complete name of person duly authorized to sign the Bid]*

Title of the person signing the Bid *[insert complete title of the person signing the Bid]*

Signature of the person named above *[insert signature of person whose name and capacity are shown above]*

Date signed *[insert date of signing]* day of *[insert month]*, *[insert year]*

*: In the case of the Bid submitted by joint venture specify the name of the Joint Venture as Bidder

** : Person signing the Bid shall have the power of attorney given by the Bidder to be attached with the Bid Schedules.

Schedules

Bill of Quantities

**1. Bill of Quantities
(Local Currency)**

Bill No. 1: General Items

<i>Item no.</i>	<i>Description</i>	<i>Unit</i>	<i>Quantity</i>	<i>Rate</i>	<i>Amount</i>
Total for Bill No. 1					_____
(carried forward to Summary, p. _____)					

Bill No. 2: Construction Works

Item No.	Description	Unit	Quantity	Rate	Amount
				Total for Bill No. 2	_____
				(carried forward to Summary, p. ____)	

Schedule of Daywork Rates: 1. Labour

Item No.	Description	Unit	Nominal quantity	Rate	Extended amount
Subtotal					
D122	Allow ___percent ^a of Subtotal for Contractor's overhead, profit, etc., in accordance with paragraph 3 (b) above.				
Total for Daywork: Labour _____ (carried forward to Daywork Summary, p. __)					

a. To be entered by the bidder.

Schedule of Daywork Rates: 2. Materials

Item No.	Description	Unit	Nominal quantity	Rate	Extended amount
Subtotal					
Allow ___ percent ^a of Subtotal for Contractor's overhead, profit, etc., in accordance with paragraph 3 (b) above.					
Total for Daywork: Materials _____ (carried forward to Daywork Summary, p. ___)					

a. To be entered by the bidder.

Schedule of Daywork Rates: 3. Contractor's Equipment

Item No.	Description	Nominal quantity (hours)	Basic hourly rental rate	Extended amount
Total for Daywork: Contractor's Equipment				_____
(carried forward to Daywork Summary, p. ____)				

Daywork Summary

	Amount ^a (MVR)	% Foreign (USD)
1. Total for Daywork: Labour		
2. Total for Daywork: Materials		
3. Total for Daywork: Contractor's Equipment		
Total for Daywork (Provisional Sum) (carried forward to Bid Summary, p. ____)	_____	_____

- a. The Employer should insert local currency unit.

Summary of Specified Provisional Sums

Bill No.	Item No.	Description	Amount
1			
2			
3			
4			
etc.			
Total for Specified Provisional Sums (carried forward to Grand Summary (B), p. ____)			

Grand Summary

Contract Name:

Contract No.:

General Summary	Page	Amount
Bill No. 1:		
Bill No. 2:		
Bill No. 3:		
— <i>etc.</i> —		
Subtotal of Bills	(A)	
Total for Daywork (Provisional Sum)	(B)	
Specified Provisional Sums included in subtotal of bills	(C)	[sum]
Total of Bills Plus Provisional Sums (A + B + C)	(D)	
Add Provisional Sum for Contingency Allowance (if any)	(E)	[sum]
Bid Price (D + E) (Carried forward to Letter of Bid)	(F)	

- i) All Provisional Sums are to be expended in whole or in part at the direction and discretion of the Engineer in accordance with Sub-Clause 13.5 of the Conditions of Contract.
- ii) To be entered by the Employer.

2. Schedule of Payment Currencies

Forinsert name of Section of the Works

Separate tables may be required if the various sections of the Works (or of the Bill of Quantities) will have substantially different foreign and local currency requirements. The Employer should insert the names of each Section of the Works.

	A	B	C	D
Name of Payment Currency	Amount of Currency	Rate of Exchange to Local Currency	Local Currency Equivalent $C = A \times B$	Percentage of Total Bid Price (TBP) $\frac{100 \times C}{TBP}$
Local currency _____		1.00		
Total Bid Price				100.00
Provisional Sums Expressed in Local Currency	<i>[To be entered by the Employer]</i>	1.00	<i>[To be entered by the Employer]</i>	
TOTAL BID PRICE (Including provisional sum)				

Schedule(s) of Adjustment Data

[In Tables A, B, and C, below, the Bidder shall (a) indicate its amount of local currency payment, (b) indicate its proposed source and base values of indices for the different foreign currency elements of cost, (c) derive its proposed weightings for local and foreign currency payment, and (d) list the exchange rates used in the currency conversion. In the case of very large and/or complex works contracts, it may be necessary to specify several families of price adjustment formulae corresponding to the different works involved.]

Table A - Local Currency

Index Code	Index Description	Source of Index	Base Value and Date	Bidder's Local Currency Amount	Bidder's Proposed Weighting
	Nonadjustable	—	—	—	A: _____* B: _____* C: _____* D: _____* E: _____*
Total					1.00

[* To be entered by the Employer. Whereas “A” should a fixed percentage, B, C, D and E should specify a range of values and the Bidder will be required to specify a value within the range such that the total weighting = 1.00]

Form of Bid Security (Bank Guarantee)

[Guarantor letterhead or SWIFT identifier code]

Beneficiary:

[Insert name and address of the Employer]

Invitation for Bids No: *_[Insert reference number for the Invitation for Bids]*

Date: *[Insert date of issue]*

BID GUARANTEE No.: *[Insert guarantee reference number]*

Guarantor: *_[Insert name and address of place of issue, unless indicated in the letterhead]*

We have been informed that *[insert name of the Bidder, which in the case of a joint venture shall be the name of the joint venture (whether legally constituted or prospective) or the names of all members thereof]* (hereinafter called "the Applicant") has submitted or will submit to the Beneficiary its bid (hereinafter called "the Bid") for the execution of *[insert description of contract]* under Invitation for Bids No. *[insert number]* ("the IFB").

Furthermore, we understand that, according to the Beneficiary's conditions, bids must be supported by a bid guarantee.

At the request of the Applicant, we, as Guarantor, hereby irrevocably undertake to pay the Beneficiary any sum or sums not exceeding in total an amount of *[insert amount in letters]* (*insert amount in numbers*) upon receipt by us of the Beneficiary's complying supported by the Beneficiary's statement, whether in the demand itself or a separate signed document accompanying or identifying the demand, stating either that the Applicant:

- (a) has withdrawn its Bid during the period of bid validity specified by the Applicant in the Letter of Bid, or any extension thereto provided by the Applicant; or
- (b) having been notified of the acceptance of its Bid by the Beneficiary during the period of bid validity, (i) fails to execute the Contract Agreement or (ii) fails to furnish the performance security, in accordance with the Instructions to Bidders ("ITB") of the Beneficiary's bidding document.

This guarantee will expire: (a) if the Applicant is the successful Bidder, upon our receipt of copies of the contract agreement signed by the Applicant and the performance security issued to the Beneficiary upon the instruction of the Applicant; and (b) if the Applicant is not the successful Bidder, upon the earlier of (i) our receipt of a copy of the Beneficiary's notification to

the Applicant of the results of the bidding process; or (ii) twenty-eight days after the Validity Period, which date shall be established by presentation to us of copies of the Letter of Bid and any extension(s) thereto, accompanied by the bidding document; or (c) three years after the date of issue of this guarantee.

Consequently, any demand for payment under this guarantee must be received by us at the office indicated above on or before that date.

This guarantee is subject to the Uniform Rules for Demand Guarantees (URDG) 2010 Revision, ICC Publication No. 758.

[signature(s)]

Note: All italicized text is for use in preparing this form and shall be deleted from the final product.

Technical Proposal

Technical Proposal Forms

Personnel

Equipment

Site Organization

Method Statement

Mobilization Schedule

Construction Schedule

Others

Bidder's Qualification

To establish its qualifications to perform the contract in accordance with Section III (Evaluation and Qualification Criteria) the Bidder shall provide the information requested in the corresponding Information Sheets included hereunder.

Form ELI -1.1: Bidder Information Form

Date: _____
 ICB No. and title: _____
 Page _____ of _____ pages

Bidder's name
In case of Joint Venture (JV), name of each member:
Bidder's actual or intended country of registration: <i>[indicate country of Constitution]</i>
Bidder's actual or intended year of incorporation:
Bidder's legal address [in country of registration]:
Bidder's authorized representative information Name: _____ Address: _____ Telephone/Fax numbers: _____ E-mail address: _____
1. Attached are copies of original documents of <input type="checkbox"/> Articles of Incorporation (or equivalent documents of constitution or association), and/or documents of registration of the legal entity named above, in accordance with ITB 4.3. <input type="checkbox"/> In case of JV, letter of intent to form JV or JV agreement, in accordance with ITB 4.1. <input type="checkbox"/> In case of Government-owned enterprise or institution, in accordance with ITB 4.5 documents establishing: <ul style="list-style-type: none"> • Legal and financial autonomy • Operation under commercial law • Establishing that the Bidder is not dependent agency of the Employer
2. Included are the organizational chart, a list of Board of Directors, and the beneficial ownership.

Form CON – 2: Historical Contract Non-Performance, Pending Litigation and Litigation History

Bidder's Name: _____

Date: _____

Joint Venture Member's Name _____

ICB No. and title: _____

Page _____ of _____ pages

Non-Performed Contracts in accordance with Section III, Evaluation Criteria and Qualifications			
<input type="checkbox"/> Contract non-performance did not occur since 1 st January [<i>insert year</i>] specified in Section III, Evaluation Criteria and Qualifications, Sub-Factor 2.1.			
<input type="checkbox"/> Contract(s) not performed since 1 st January [<i>insert year</i>] specified in Section III, Evaluation Criteria and Qualifications, requirement 2.1			
Year	Non-performed portion of contract	Contract Identification	Total Contract Amount (current value, currency, exchange rate and US\$ equivalent)
		Contract Identification: Name of Employer: Address of Employer: Reason(s) for non performance:	
Pending Litigation, in accordance with Section III, Evaluation Criteria and Qualifications			
<input type="checkbox"/> No pending litigation in accordance with Section III, Evaluation Criteria and Qualifications, Sub-Factor 2.3.			
<input type="checkbox"/> Pending litigation in accordance with Section III, Evaluation Criteria and Qualifications, Sub-Factor 2.3 as indicated below.			

Form CCC: Current Contract Commitments / Works in Progress

Bidders and each partner to a JV should provide information on their current commitments on all contracts that have been awarded, or for which a letter of intent or acceptance has been received, or for contracts approaching completion, but for which an unqualified, full completion certificate has yet to be issued.

Name of contract	Employer, contact address/tel/fax	Value of outstanding work (current MVR equivalent)	Estimated completion date	Average monthly invoicing over last six months (MVR/month)
1.				
2.				
3.				
4.				
5.				
etc.				

Form FIN – 3.1: Financial Situation and Performance

Bidder's Name: _____

Date: _____

Joint Venture Member's Name _____

ICB No. and title: _____

Page _____ of _____ pages

1. Financial data

Type of Financial information in (currency)	Historic information for previous _____ years, _____		
	(amount in currency, currency, exchange rate, USD equivalent)		
	Year 1	Year 2	Year 3
Statement of Financial Position (Information from Balance Sheet)			
Total Assets (TA)			
Total Liabilities (TL)			
Total Equity/Net Worth (NW)			
Current Assets (CA)			
Current Liabilities (CL)			
Working Capital (WC)			
Information from Income Statement			
Total Revenue (TR)			
Profits Before Taxes (PBT)			
Cash Flow Information			
Cash Flow from Operating Activities			

*Refer to ITB 15 for the exchange rate.

2. Sources of Finance

Specify sources of finance to meet the cash flow requirements on works currently in progress and for future contract commitments.

No.	Source of finance	Amount (MVR equivalent)
1		
2		
3		

2. Financial documents

The Bidder and its parties shall provide copies of financial statements for _____ years pursuant Section III, Evaluation and Qualifications Criteria, Sub-factor 3.2. The financial statements shall:

- (a) reflect the financial situation of the Bidder or in case of JV member , and not an affiliated entity (such as parent company or group member).
- (b) be independently audited or certified in accordance with local legislation.
- (c) be complete, including all notes to the financial statements.
- (d) correspond to accounting periods already completed and audited.

Attached are copies of financial statements¹³ for the _____ years required above; and complying with the requirements

¹³ If the most recent set of financial statements is for a period earlier than 12 months from the date of bid, the reason for this should be justified.

Form FIN - 3.2: Average Annual Construction Turnover

Bidder's Name; Date: _____
 Joint Venture Member's Name _____
 ICB No. and title: _____
 Page _____ of _____ pages

	Annual turnover data (construction only)
Year	Amount Currency (MVR)
<i>[indicate year]</i>	<i>[insert amount and indicate currency]</i>
Average Annual Construction Turnover *	

* See Section III, Evaluation and Qualification Criteria, Sub-Factor 3.2.

Form FIN3.3: Financial Resources

Specify proposed sources of financing, such as liquid assets, unencumbered real assets, lines of credit, and other financial means, net of current commitments, available to meet the total construction cash flow demands of the subject contract or contracts as specified in Section III (Evaluation and Qualification Criteria)

Source of financing	Amount (MVR equivalent)
1.	
2.	
3.	
4.	

Form EXP - 4.1: General Construction Experience

Bidder's Name: _____
 Date: _____
 Joint Venture Member's Name _____
 ICB No. and title: _____
 Page _____ of _____ pages

Starting Year	Ending Year	Contract Identification	Role of Bidder
		Contract name: _____ Brief Description of the Works performed by the Bidder: _____ Amount of contract: _____ Name of Employer: _____ Address: _____	
		Contract name: _____ Brief Description of the Works performed by the Bidder: _____ Amount of contract: _____ Name of Employer: _____ Address: _____	
		Contract name: _____ Brief Description of the Works performed by the Bidder: _____ Amount of contract: _____ Name of Employer: _____ Address: _____	

Form EXP - 4.2(a): Specific Construction and Contract Management Experience

Bidder's Name: _____

Date: _____

Joint Venture Member's Name _____

ICB No. and title: _____

Page _____ of _____ pages

Similar Contract No.	Information			
Contract Identification				
Award date				
Completion date				
Role in Contract	Prime Contractor <input type="checkbox"/>	Member in JV <input type="checkbox"/>	Management Contractor <input type="checkbox"/>	Sub-contractor <input type="checkbox"/>
Total Contract Amount				US\$ *
If member in a JV or sub-contractor, specify participation in total Contract amount			*	
Employer's Name:				
Address:				
Telephone/fax number				
E-mail:				

Form EXP - 4.2(a) (cont.)
Specific Construction and Contract Management Experience (cont.)

Similar Contract No.	Information
Description of the similarity in accordance with Sub-Factor 4.2(a) of Section III:	
1. Amount	
2. Physical size of required works items	
3. Complexity	
4. Methods/Technology	
5. Construction rate for key activities	
6. Other Characteristics	

Section V - Eligible Countries

1. In reference to ITB 4.7, and 5.1, for the information of the Bidders, at the present time firms, goods and services from the following countries are excluded from this bidding process:

Under ITB 4.7 (a) and 5.1 **“None”**

Under ITB 4.7 (b) and 5.1 **“None”**

Section VI. Fund Policy - Corrupt and Fraudulent Practices

(Section VI shall not be modified)

“Fraud and Corruption”:

1.16 It is the Fund’s policy to require that Beneficiary’s (including beneficiaries of Fund loans), bidders, suppliers, contractors and their agents (whether declared or not), sub-contractors, sub-consultants, service providers or suppliers, and any personnel thereof, observe the highest standard of ethics during the procurement and execution of Fund-financed contracts.¹⁴ In pursuance of this policy, the Fund:

- (a) defines, for the purposes of this provision, the terms set forth below as follows:
 - (i) “corrupt practice” is the offering, giving, receiving, or soliciting, directly or indirectly, of anything of value to influence improperly the actions of another party;¹⁵;
 - (ii) “fraudulent practice” is any act or omission, including a misrepresentation, that knowingly or recklessly misleads, or attempts to mislead, a party to obtain a financial or other benefit or to avoid an obligation;¹⁶
 - (iii) “collusive practice” is an arrangement between two or more parties designed to achieve an improper purpose, including to influence improperly the actions of another party;¹⁷
 - (iv) “coercive practice” is impairing or harming, or threatening to impair or harm, directly or indirectly, any party or the property of the party to influence improperly the actions of a party;¹⁸
 - (v) “obstructive practice” is
 - (aa) deliberately destroying, falsifying, altering, or concealing of evidence material to the investigation or making false statements to investigators in order to materially impede a Bank investigation into

¹⁴ In this context, any action to influence the procurement process or contract execution for undue advantage is improper.

¹⁵ For the purpose of this sub-paragraph, “*another party*” refers to a public official acting in relation to the procurement process or contract execution. In this context, “*public official*” includes Fund staff and employees of other organizations taking or reviewing procurement decisions.

¹⁶ For the purpose of this sub-paragraph, “*party*” refers to a public official; the terms “*benefit*” and “*obligation*” relate to the procurement process or contract execution; and the “*act or omission*” is intended to influence the procurement process or contract execution.

¹⁷ For the purpose of this sub-paragraph, “*parties*” refers to participants in the procurement process (including public officials) attempting either themselves, or through another person or entity not participating in the procurement or selection process, to simulate competition or to establish bid prices at artificial, non-competitive levels, or are privy to each other’s bid prices or other conditions.

¹⁸ For the purpose of this sub-paragraph, “*party*” refers to a participant in the procurement process or contract execution.

allegations of a corrupt, fraudulent, coercive or collusive practice; and/or threatening, harassing or intimidating any party to prevent it from disclosing its knowledge of matters relevant to the investigation or from pursuing the investigation, or

- (bb) acts intended to materially impede the exercise of the Fund's inspection and audit rights provided for;
- (b) will reject a proposal for award if it determines that the bidder recommended for award, or any of its personnel, or its agents, or its sub-consultants, sub-contractors, service providers, suppliers and/or their employees, has, directly or indirectly, engaged in corrupt, fraudulent, collusive, coercive, or obstructive practices in competing for the contract in question;
- (c) will declare misprocurement and cancel the portion of the loan allocated to a contract if it determines at any time that representatives of the Beneficiary or of a recipient of any part of the proceeds of the loan engaged in corrupt, fraudulent, collusive, coercive, or obstructive practices during the procurement or the implementation of the contract in question, without the Beneficiary having taken timely and appropriate action satisfactory to the Fund to address such practices when they occur, including by failing to inform the Fund in a timely manner at the time they knew of the practices; and
- (d) will sanction a firm or individual, at any time, in accordance with the prevailing Fund's sanctions procedures,¹⁹ including by publicly declaring such firm or individual ineligible, either indefinitely or for a stated period of time: (i) to be awarded a Fund-financed contract; and (ii) to be a nominated²⁰;
- (e) will require that a clause be included in bidding documents and in contracts financed by a Fund loan, requiring bidders, suppliers and contractors, and their sub-contractors, agents, personnel, consultants, service providers, or suppliers, to permit the Fund to inspect all accounts, records, and other documents relating to the submission of bids and contract performance, and to have them audited by auditors appointed by the Fund.”

¹⁹ A firm or individual may be declared ineligible to be awarded a Fund financed contract upon: (i) completion of the Fund's sanctions proceedings as per its sanctions procedures, including, inter alia, cross-debarment as agreed with other International Financial Institutions, including Multilateral Development Banks, and through the application the Fund administrative procurement sanctions procedures for fraud and corruption; and (ii) as a result of temporary suspension or early temporary suspension in connection with an ongoing sanctions proceeding. See footnote 14 and paragraph 8 of Appendix 1 of these Guidelines.

²⁰ A nominated sub-contractor, consultant, manufacturer or supplier, or service provider (different names are used depending on the particular bidding document) is one which has either been: (i) included by the bidder in its pre-qualification application or bid because it brings specific and critical experience and know-how that allow the bidder to meet the qualification requirements for the particular bid; or (ii) appointed by the Beneficiary.

PART 2 – Works Requirements

Section VII - Works Requirements

Table of Contents

Scope of Works.....	2-80
Specifications.....	2-580
Drawings.....	2-82
Bill of Quantities.....	2-Error! Bookmark not defined.

Scope of Works

Procurement Reference Number: *OFIDPMU/2017/PH2-003*

Introduction

The Government of the Republic of Maldives has received financing from the OPEC Fund for International Development (OFID), and intends to procure a contractor to establish Island Waste Management Centres in Zone 1, Maldives. To this regard, Island council of the respective island has acquired land for this purpose. The island waste management centers are the focal point for waste management activities on inhabited islands. Separated wastes are properly managed and safely stored at these centers for periods of up to 3 months, which allows sufficient flexibility to transfer these waste to Regional Waste Management Center.

Goals and Objectives

This project seeks to improve and develop a socially and environmentally sustainable system of solid waste management in the Upper North Region, which reduces the associated environmental and public health risks.

The project is aligned with the National Solid Waste Management Policy to extend services to all inhabited islands, support regional development and encourage private sector participation in waste management service delivery. This project contributes towards maintaining a high level of environmental integrity and sound environmental management in the islands. By improving the manner in which inhabited islands manage their wastes, the project would also support sustainable tourism development objectives.

The overall objective of the project is to establish a proper and an efficient waste management system in the islands that are locally appropriate, environmentally sound and financially viable. However the specific objective of this assignment is to ensure that the construction of IWMCs are in compliance with the existing relevant laws and regulations.

Brief Description of Works

This project is proposed the construction of Island Waste Management Centre at H.Dh.Kumundhoo (H.Dh.Kumundhoo Waste Collection yard). To this regard, land has been allocated for the establishment of Island Waste Management Center. The works shall be

carried out in accordance to the Bill of Quantities, Drawing and Technical Specification provided.

Location of Works

H.Dh.Kumundhoo, Haa Dhaalu Atoll, Maldives

Commencement and Completion Periods Required

Commencement: 14 days from signing of contract.

Completion Period: 90 days after signing of the contract.

Drawings

The Works are to be performed in accordance with the following attached Drawings:

1. *Drawings [Attached]*.

Bill of Quantities

The Works are to be performed in accordance with the following attached Bill of Quantities:

1. *Bill of Quantities [Attached].*

PART 3 – Conditions of Contract and Contract Forms

Section VIII. General Conditions of Contract

Note: The General Conditions mentioned herein are the same as the MDB's Harmonized Edition of the Conditions of Contract for Construction prepared and copyrighted by the International Federation of Consulting Engineers (Fédération Internationale des Ingénieurs-Conseils, or FIDIC), FIDIC 2010 which is available at www.fidic.org.

Section IX. Particular Conditions of Contract

The following Particular Conditions shall supplement the GC. Whenever there is a conflict, the provisions herein shall prevail over those in the GCC.

Except where otherwise specified, all PCC should be filled in by the Employer prior to issuance of the Bidding Documents. Schedules and reports to be provided by the Employer should be annexed.

Part A - Contract Data

Conditions	Sub-Clause	Data
Employer's name and address	1.1.2.2 & 1.3	Ministry of Environment and Energy, Ameenu Magu, Male', Republic of Maldives.
Engineer's name and address	1.1.2.4 & 1.3	Same as Employer
Fund's name	1.1.2.11	OFID/ GOVERNMENT OF MALDIVES
Beneficiary's name	1.1.2.12	<u>Government of Maldives</u>
Time for Completion	1.1.3.3	90 Days
Defects Notification Period	1.1.3.7	180 days.
Sections	1.1.5.6	NA
Electronic transmission systems	1.3	Email
Governing Law	1.4	The law is that in force in the Republic of Maldives.
Ruling language	1.4	English
Language for communications	1.4	English
Time for the Parties entering into a Contract Agreement	1.6	14 days
Inspections and Audit by the Fund	1.15	This clause shall be amended as follows: The Contractor shall permit, and shall cause its agents (whether declared or not), sub-contractors, sub-consultants, service providers, or suppliers and any personnel thereof, to permit, the Fund and/or persons appointed by the Fund to inspect the Site and all accounts and records relating to the performance of the Contract and the submission of the bid, and to have such accounts and records audited by auditors appointed by the Fund if requested by the Fund. The Contractor's attention is drawn to Sub-Clause 15.6 [Corrupt or Fraudulent Practices] which provides, inter alia, that acts intended to materially impede the exercise of the Fund's inspection and audit rights provided for under Sub-Clause 1.15 constitute a prohibited practice subject to

		contract termination (as well as to a determination of ineligibility pursuant to the Fund's prevailing sanctions procedures.
Time for access to the Site	2.1	No later than the Commencement Day, except for the following parts (if applicable, with detailed description of parts concerned: <u>14 days after Commencement Date</u>
Engineer's Duties and Authority	3.1(b)(ii)	The Engineer shall obtain the specific approval of the Employer before ordering any works involving delay or any extra payment by the Employer or to make variation of or in the Works or Contract
Performance Security	4.2	The performance security will be in the form of a "performance bond" in the amount(s) of <i>Five (5%)</i> percent of the Accepted Contract Amount and in the same currency(ies) of the Accepted Contract Amount.
Normal working hours	6.5	12 hours.
Commencement of Works	8.1	Within 14 Days of Contract Signing.
Delay damages for the Works	8.7 & 14.15(b)	<u>0.75</u> % of the Contract Price per Days.
Maximum amount of delay damages	8.7	15 % of the final Contract Price.
Provisional Sums	13.5.(b)(ii)	Not Applicable
Adjustments for Changes in Cost	13.8	Not Applicable
Total advance payment	14.2	15 % Percentage of the Accepted Contract Amount payable in the currencies and proportions in which the Accepted Contract Amount is payable.
Repayment amortization rate of advance payment	14.2(b)	15 %
Percentage of Retention	14.3	5 %
Limit of Retention Money	14.3	5 % of the Accepted Contract Amount
Plant and Materials	14.5(b)(i)	If Sub-Clause 14.5 applies: N/A

	14.5(c)(i)	N/A
Minimum Amount of Interim Payment Certificates	14.6	10 % of the Accepted Contract Amount
Publishing source of commercial penalty rates for financial charges in case of delayed payment	14.8	NOT APPLICABLE
Maximum total liability of the Contractor to the Employer	17.6	The product of 2.5 times the Accepted Contract Amount.
Periods for submission of insurance:	18.1	
a. evidence of insurance.		N/A
b. relevant policies		N/A
Date by which the DB shall be appointed	20.2	28 days after the Commencement date
The DB shall be comprised of	20.2	Three Members
Appointment (if not agreed) to be made by	20.3	National tender Board (Maldives) to appoint 3 impartial members. Can be from MoFT, Tender Section, GoM directorates, or Private sector
Rules of arbitration	20.6(a)	<i>Maldives</i>

Part B - Specific Provisions

Sub-Clause 14.1

The Contract Price

(Alternative paragraph)

- (e) Notwithstanding the provisions of subparagraph (b), Contractor's Equipment, including essential spare parts therefore, imported by the Contractor for the sole purpose of executing the Contract shall be temporarily exempt from the payment of import duties and taxes upon initial importation, provided the Contractor shall post with the customs authorities at the port of entry an approved export bond or bank guarantee, valid until the Time for Completion plus six months, in an amount equal to the full import duties and taxes which would be payable on the assessed imported value of such Contractor's Equipment and spare parts, and callable in the event the Contractor's Equipment is not exported from the Country on completion of the Contract. A copy of the bond or bank guarantee endorsed by the customs authorities shall be provided by the Contractor to the Employer upon the importation of individual items of Contractor's Equipment and spare parts. Upon export of individual items of Contractor's Equipment or spare parts, or upon the completion of the Contract, the Contractor shall prepare, for approval by the customs authorities, an assessment of the residual value of the Contractor's Equipment and spare part to be exported, based on the depreciation scale(s) and other criteria used by the customs authorities for such purposes under the provisions of the applicable Laws. Import duties and taxes shall be due and payable to the customs authorities by the Contractor on (a) the difference between the initial imported value and the residual value of the Contractor's Equipment and spare parts to be exported; and (b) on the initial imported value that Contractor's Equipment and spare parts remaining in the Country after completion of the Contract. Upon payment of such dues within 28 days of being invoiced, the bond or bank guarantee shall be reduced or released accordingly; otherwise the security shall be called in the full amount remaining.

Section X - Contract Forms

This Section contains forms which, once completed, will form part of the Contract. The forms for Performance Security and Advance Payment Security, when required, shall only be completed by the successful Bidder after contract award.

Table of Forms

Letter of Acceptance.....	X-10
Contract Agreement.....	X-11
Performance Security (Bank Guarantee).....	X-13
Performance Security (Performance Bond).....	X-15
Advance Payment Security	X-17
Retention Money Security.....	X-19

Letter of Acceptance

[on letterhead paper of the Employer]

..... *[date]*

To: *[name and address of the Contractor]*

Subject: *[Notification of Award Contract No.]*

This is to notify you that your Bid dated *[insert date]* for execution of the
. . . . *[insert name of the contract and identification number, as given in the BDS]* for
the Accepted Contract Amount of *[insert amount in numbers and words and name of
currency]*, as corrected and modified in accordance with the Instructions to Bidders is
hereby accepted by our Agency.

You are requested to furnish the Performance Security within 28 days in accordance
with the Conditions of Contract, using for that purpose one of the of the Performance
Security Form included in Section X. Contract Forms, of the Bidding Document.

Authorized Signature:

Name and Title of Signatory:

Name of Agency:

Attachment: Contract Agreement

Contract Agreement

THIS AGREEMENT made theday of,, between
 . [name of the Employer]. (hereinafter “the Employer”), of the one part, and
 [name of the Contractor].(hereinafter “the Contractor”), of the other part:

WHEREAS the Employer desires that the Works known as [name of the Contract].
 .should be executed by the Contractor, and has accepted a Bid by the Contractor for the
 execution and completion of these Works and the remedying of any defects therein,

The Employer and the Contractor agree as follows:

1. In this Agreement words and expressions shall have the same meanings as are respectively assigned to them in the Contract documents referred to.
2. The following documents shall be deemed to form and be read and construed as part of this Agreement. This Agreement shall prevail over all other Contract documents.
 - (i) the Letter of Acceptance
 - (ii) the Letter of Bid
 - (iii) the addenda Nos _____(if any)
 - (iv) the Particular Conditions
 - (v) the General Conditions of Contract
 - (vi) the Specification
 - (vii) the Drawings
 - (viii) Bill of Quantities; and
 - (ix) any other document **listed in the PCC** as forming part of the Contract,
3. In consideration of the payments to be made by the Employer to the Contractor as specified in this Agreement, the Contractor hereby covenants with the Employer to execute the Works and to remedy defects therein in conformity in all respects with the provisions of the Contract.
4. The Employer hereby covenants to pay the Contractor in consideration of the execution and completion of the Works and the remedying of defects therein, the Contract Price or such other sum as may become payable under the provisions of the Contract at the times and in the manner prescribed by the Contract.

IN WITNESS whereof the parties hereto have caused this Agreement to be executed in accordance with the laws of *[name of the beneficiary country]*. . . .on the day, month and year specified above.

Signed by:
for and on behalf of the Employer

Signed by:
for and on behalf the Contractor

in the
presence of:
Witness, Name, Signature, Address, Date

in the
presence of:
Witness, Name, Signature, Address, Date

Performance Security (Bank Guarantee)

Option 1: (Bank Guarantee)

[Guarantor letterhead or SWIFT identifier code]

Beneficiary: *[insert name and Address of Employer]*

Date: *_ [Insert date of issue]*

PERFORMANCE GUARANTEE No.: *[Insert guarantee reference number]*

Guarantor: *[Insert name and address of place of issue, unless indicated in the letterhead]*

We have been informed that *_ [insert name of Contractor, which in the case of a joint venture shall be the name of the joint venture]* (hereinafter called "the Applicant") has entered into Contract No. *[insert reference number of the contract]* dated *[insert date]* with the Beneficiary, for the execution of *_ [insert name of contract and brief description of Works]* (hereinafter called "the Contract").

Furthermore, we understand that, according to the conditions of the Contract, a performance guarantee is required.

At the request of the Applicant, we as Guarantor, hereby irrevocably undertake to pay the Beneficiary any sum or sums not exceeding in total an amount of *[insert amount in figures]* (_____) *[insert amount in words]*,¹ such sum being payable in the types and proportions of currencies in which the Contract Price is payable, upon receipt by us of the Beneficiary's complying demand supported by the Beneficiary's statement, whether in the demand itself or in a separate signed document accompanying or identifying the demand, stating that the Applicant is in breach of its obligation(s) under the Contract, without the Beneficiary needing to prove or to show grounds for your demand or the sum specified therein.

This guarantee shall expire, no later than the Day of, 2...², and any demand for payment under it must be received by us at this office indicated above on or before that date.

¹ *The Guarantor shall insert an amount representing the percentage of the Accepted Contract Amount specified in the Letter of Acceptance, less provisional sums, if any, and denominated either in the currency(cies) of the Contract or a freely convertible currency acceptable to the Beneficiary.*

² *Insert the date twenty-eight days after the expected completion date as described in GC Clause 53.1. The Employer should note that in the event of an extension of this date for completion of the Contract, the Employer would need to request an extension of this guarantee from the Guarantor. Such request must be in writing and must be made prior to the expiration date established in the guarantee. In preparing this guarantee, the Employer might consider adding the following text to the form, at the end of the penultimate paragraph: "The Guarantor agrees to a one-time extension of this guarantee for a period not to exceed [six months][one year], in response to the Beneficiary's written request for such extension, such request to be presented to the Guarantor before the expiry of the guarantee."*

This guarantee is subject to the Uniform Rules for Demand Guarantees (URDG) 2010 Revision, ICC Publication No. 758, except that the supporting statement under Article 15(a) is hereby excluded.

[signature(s)]

Note: All italicized text (including footnotes) is for use in preparing this form and shall be deleted from the final product.

Performance Security (Performance Bond)

Option 2: Performance Bond

By this Bond [*insert name of Principal*] as Principal (hereinafter called “the Contractor”) and [*insert name of Surety*] as Surety (hereinafter called “the Surety”), are held and firmly bound unto [*insert name of Employer*] as Obligee (hereinafter called “the Employer”) in the amount of [*insert amount in words and figures*], for the payment of which sum well and truly to be made in the types and proportions of currencies in which the Contract Price is payable, the Contractor and the Surety bind themselves, their heirs, executors, administrators, successors and assigns, jointly and severally, firmly by these presents.

WHEREAS the Contractor has entered into a written Agreement with the Employer dated the _____ day of _____, 20 ____, for [*name of contract and brief description of Works*] in accordance with the documents, plans, specifications, and amendments thereto, which to the extent herein provided for, are by reference made part hereof and are hereinafter referred to as the Contract.

NOW, THEREFORE, the Condition of this Obligation is such that, if the Contractor shall promptly and faithfully perform the said Contract (including any amendments thereto), then this obligation shall be null and void; otherwise, it shall remain in full force and effect. Whenever the Contractor shall be, and declared by the Employer to be, in default under the Contract, the Employer having performed the Employer’s obligations thereunder, the Surety may promptly remedy the default, or shall promptly:

- (1) complete the Contract in accordance with its terms and conditions; or
- (2) obtain a Bid or bids from qualified Bidders for submission to the Employer for completing the Contract in accordance with its terms and conditions, and upon determination by the Employer and the Surety of the lowest responsive Bidder, arrange for a Contract between such Bidder and Employer and make available as work progresses (even though there should be a default or a succession of defaults under the Contract or Contracts of completion arranged under this paragraph) sufficient funds to pay the cost of completion less the Balance of the Contract Price; but not exceeding, including other costs and damages for which the Surety may be liable hereunder, the amount set forth in the first paragraph hereof. The term “Balance of the Contract Price,” as used in this paragraph, shall mean the total amount payable by Employer to Contractor under the Contract, less the amount properly paid by Employer to Contractor; or
- (3) pay the Employer the amount required by Employer to complete the Contract in accordance with its terms and conditions up to a total not exceeding the amount of this Bond.

The Surety shall not be liable for a greater sum than the specified penalty of this Bond.

Any suit under this Bond must be instituted before the expiration of one year from the date of the issuing of the Taking-Over Certificate.

No right of action shall accrue on this Bond to or for the use of any person or corporation other than the Employer named herein or the heirs, executors, administrators, successors, and assigns of the Employer.

In testimony whereof, the Contractor has hereunto set his hand and affixed his seal, and the Surety has caused these presents to be sealed with his corporate seal duly attested by the signature of his legal representative, this _____ day of _____ 20 ____.

SIGNED ON _____ on behalf of _____

By _____ in the capacity of _____

In the presence of _____

SIGNED ON _____ on behalf of _____

By _____ in the capacity of _____

In the presence of _____

Advance Payment Security

[Guarantor letterhead or SWIFT identifier code]

Beneficiary: *[Insert name and Address of Employer]*

Date: *[Insert date of issue]*

ADVANCE PAYMENT GUARANTEE No.: *[Insert guarantee reference number]*

Guarantor: *[Insert name and address of place of issue, unless indicated in the letterhead]*

We have been informed that *[insert name of Contractor, which in the case of a joint venture shall be the name of the joint venture]* (hereinafter called "the Applicant") has entered into Contract No. *[insert reference number of the contract]* dated *[insert date]* with the Beneficiary, for the execution of *[insert name of contract and brief description of Works]* (hereinafter called "the Contract").

Furthermore, we understand that, according to the conditions of the Contract, an advance payment in the sum *[insert amount in figures]* () *[insert amount in words]* is to be made against an advance payment guarantee.

At the request of the Applicant, we as Guarantor, hereby irrevocably undertake to pay the Beneficiary any sum or sums not exceeding in total an amount of *[insert amount in figures]* () *[insert amount in words]*¹ upon receipt by us of the Beneficiary's complying demand supported by the Beneficiary's statement, whether in the demand itself or in a separate signed document accompanying or identifying the demand, stating either that the Applicant:

- (a) has used the advance payment for purposes other than the costs of mobilization in respect of the Works; or
- (b) has failed to repay the advance payment in accordance with the Contract conditions, specifying the amount which the Applicant has failed to repay.

A demand under this guarantee may be presented as from the presentation to the Guarantor of a certificate from the Beneficiary's bank stating that the advance payment referred to above has been credited to the Applicant on its account number *[insert number]* at *[insert name and address of Applicant's bank]*..

¹ *The Guarantor shall insert an amount representing the amount of the advance payment and denominated either in the currency(ies) of the advance payment as specified in the Contract, or in a freely convertible currency acceptable to the Employer.*

The maximum amount of this guarantee shall be progressively reduced by the amount of the advance payment repaid by the Applicant as specified in copies of interim statements or payment certificates which shall be presented to us. This guarantee shall expire, at the latest, upon our receipt of a copy of the interim payment certificate indicating that ninety (90) percent of the Accepted Contract Amount, less provisional sums, has been certified for payment, or on the [insert day] day of [insert month], 2 [insert year],² whichever is earlier. Consequently, any demand for payment under this guarantee must be received by us at this office on or before that date.

This guarantee is subject to the Uniform Rules for Demand Guarantees (URDG) 2010 Revision, ICC Publication No. 758, except that the supporting statement under Article 15(a) is hereby excluded.

[signature(s)]

Note: All italicized text (including footnotes) is for use in preparing this form and shall be deleted from the final product.

² Insert the expected expiration date of the Time for Completion. The Employer should note that in the event of an extension of the time for completion of the Contract, the Employer would need to request an extension of this guarantee from the Guarantor. Such request must be in writing and must be made prior to the expiration date established in the guarantee. In preparing this guarantee, the Employer might consider adding the following text to the form, at the end of the penultimate paragraph: “The Guarantor agrees to a one-time extension of this guarantee for a period not to exceed [six months][one year], in response to the Beneficiary’s written request for such extension, such request to be presented to the Guarantor before the expiry of the guarantee.”

Retention Money Security

Demand Guarantee

_____ [*Guarantor letter head or SWIFT identifier code*]

Beneficiary: _____ [*Insert name and Address of Employer*]

Date: _____ [*Insert date of issue*]

RETENTION MONEY GUARANTEE No.: _____ [*Insert guarantee reference number*]

Guarantor: [*Insert name and address of place of issue, unless indicated in the letterhead*]

We have been informed that _____ [*insert name of Contractor, which in the case of a joint venture shall be the name of the joint venture*] (hereinafter called "the Applicant") has entered into Contract No. _____ [*insert reference number of the contract*] dated _____ with the Beneficiary, for the execution of _____ [*insert name of contract and brief description of Works*](hereinafter called "the Contract").

Furthermore, we understand that, according to the conditions of the Contract, the Beneficiary retains moneys up to the limit set forth in the Contract ("the Retention Money"), and that when the Taking-Over Certificate has been issued under the Contract and the first half of the Retention Money has been certified for payment, payment of [*insert thesecond half of the Retention Moneyor if the amount guaranteed under the Performance Guarantee when the Taking-Over Certificate is issued is less than half of the Retention Money,thedifference between half of the Retention Money and the amount guaranteed under the Performance Security*] is to be made against a Retention Money guarantee.

At the request of the Applicant, we,as Guarantor, hereby irrevocably undertake to pay the Beneficiary any sum or sums not exceeding in total an amount of _____ [*insert amount in figures*](*)*[*amount in words*]¹ upon receipt by us of the Beneficiary's complying demand supported by the Beneficiary's statement, whether in the demand itself or in a

¹ The Guarantor shall insert an amount representing the amount of the second half of the Retention Money or or if the amount guaranteed under the Performance Guarantee when the Taking-Over Certificate is issued is less than half of the Retention Money, the difference between half of the Retention Money and the amount guaranteed under the Performance Security and denominated either in the currency(ies) of the second half of the Retention Money as specified in the Contract, or in a freely convertible currency acceptable to the Beneficiary.

separate signed document accompanying or identifying the demand, stating that the Applicant is in breach of its obligation(s) under the Contract, without your needing to prove or show grounds for your demand or the sum specified therein.

A demand under this guarantee may be presented as from the presentation to the Guarantor of a certificate from the Beneficiary's bank stating that the second half of the Retention Money as referred to above has been credited to the Applicant on its account number _____ at _____ *[insert name and address of Applicant's bank]*.

This guarantee shall expire no later than the day of, 2...², and any demand for payment under it must be received by us at the office indicated above on or before that date.

This guarantee is subject to the Uniform Rules for Demand Guarantees (URDG) 2010 Revision, ICC Publication No. 758, except that the supporting statement under Article 15(a) is hereby excluded.

[signature(s)]

Note: All italicized text (including footnotes) is for use in preparing this form and shall be deleted from the final product.

² *Insert the same expiry date as set forth in the performance security, representing the date twenty-eight days after the completion date described in GC Clause 11.9. The Employer should note that in the event of an extension of this date for completion of the Contract, the Employer would need to request an extension of this guarantee from the Guarantor. Such request must be in writing and must be made prior to the expiration date established in the guarantee. In preparing this guarantee, the Employer might consider adding the following text to the form, at the end of the penultimate paragraph: "The Guarantor agrees to a one-time extension of this guarantee for a period not to exceed [six months][one year], in response to the Beneficiary's written request for such extension, such request to be presented to the Guarantor before the expiry of the guarantee."*



ދިވެހިސަރުކާރުގެ ގެޒެޓް ގައި ބަޔާންކުރި ގޮތުގައި

ދިވެހިސަރުކާރުގެ ގެޒެޓް ގައި ބަޔާންކުރި ގޮތުގައި

ދިވެހިސަރުކާރުގެ ގެޒެޓް ގައި ބަޔާންކުރި ގޮތުގައި

ISLAND WASTE MANAGEMENT CENTRE HDh. Kumundhoo



Uniting against Poverty

CONSTRUCTION OF WASTE COLLECTION CENTRE - HAA DHAALU KUMUNDHOO
Bill of Quantities
SUMMARY SHEET

Bill No	Item	Amount
1	Preliminaries	
2	Site clearance	
3	Earth works	
4	Concrete works	
5	Masonry works	
6	Plastering works	
7	Structural steel works	
8	Painting works	
9	Electrical works	
10	Doors and windows	
11	Roofing works	
12	Plumbing works	
13	Others	
	Sub Total	
	GST 6%	
	GRAND TOTAL	

CONSTRUCTION OF WASTE COLLECTION CENTRE - HAA DHAAL KUMUNDHOO

Bill of Quantities

No	Item	Unit	Quantity	Rate	Amount
1	Preliminaries				
1.1	Mobilization to site	LS	1		
1.2	Site management cost including set up of tempory services for contractor's services as maybe ncessary	Months	1		
1.3	Setup sign board on site	LS	1		
1.4	Clean up site upon completion of works	LS	1		
1.5	Demobilization	LS	1		
2	Site Clearance				
2.1	Allow for any remaining site clearance.	LS	1		
3	Earth works				
	Allow for all excavation work for foundations as follows				
3.1	Perimeter fence wall	m3	6.30		
3.2	Perimeter fence footings	m3	2.38		
3.3	Flood light pole	m3	0.29		
3.4	Levelling and compaction of ground for compost slab	m2	75		
3.5	Levelling and compaction of ground for sorting slab	m2	75		
3.6	Setting up a ground water well in the location shown	LS	1		
3.7	Storage area footings	m3	0.58		
3.8	Leachate collection tank	m3	2.48		
3.9	Levelling and compaction of ground for storage area slab	m2	59.54		
3.10	Line footing for 3m high wall	m3	1.47		
4	Concrete works				
4.1	Foundation for perimeter fence column footings	m3	2.38		
4.2	Foundation for lighting poles	m3	0.29		
4.3	Casting of compost slab. Reinforcement shall be provided as shown on drawing	m3	5.80		
4.4	Casting of B1 beams. Reinforcement shall be provided as shown on drawing.	m3	3.51		
4.5	Casting of B2 beams. Reinforcement shall be provided as shown on drawing.	m3	0.79		
4.6	Casting of B3 beams. Reinforcement shall be provided as shown on drawing.	m3	1.35		
4.7	Casting of leachate collection tanks. Reinforcement shall be provided as shown on drawing.	No	1		
4.8	Outdoor concrete sorting slab	m3	7.5		
4.9	Casting of 900mm well with base slab and top cover slab	LS	1		

4.10	Casting of storage area footings	m3	0.58		
4.11	Casting of storage area slab	m3	4.47		
4.12	Casting of line footing for 3m high wall	m3	1.47		
4.13	Casting of indoor sorting platform	m3	0.80		
5	Masonry works				
	<i>200mm thick walls</i>				
5.1	600mm high wall for perimeter fence	m	105		
5.2	850mm high wall for sorting platform	m	2.4		
5.3	50mm lean concrete for fence wall	m	105		
	<i>150mm thick walls</i>				
5.3	1500 high wall above for waste storage area	m	13.5		
5.4	3000 high wall in waste storage area	m	34.45		
6	Plastering works				
	<i>200mm thick walls</i>				
6.1	12.5mm plastering on 600mm high wall for perimeter fence	m2	147		
6.2	12.5mm plastering on 850mm high wall for sorting platform	m2	4.08		
	<i>150mm thick walls</i>				
6.3	12.5mm plastering on 1500mm high wall for waste storage area	m2	40.5		
6.4	12.5mm plastering on 3000mm high wall for waste storage area	m2	206.7		
7	Structural steel works				
7.1	Perimeter fence using 50mm & 38mm G.I pipe as shown on drawing. Rate shall include all cuttings, weldings, applying of protective coating for welded joints, and, setting up the fence.	m	105		
7.2	Provide 75mm G.I pipe as flood light fixing poles. Rate shall include installation charges as shown on drawing.	Nos	2		
7.3	Provide 75mm G.I pipe to fix roof of waste storage area. Rate shall include all cuts, welds and applying of protective coating for welded joints and setting up of the pipes	Nos	16		
7.4	Provide 38mm G.I bearer pipes as shown on drawing. Rate shall include all cuts, welds and applying protective coating on welded joints	m	46.2		
7.5	Provide 38mm G.I purlin pipes as shown on drawing. Rate shall include all cuts, welds and applying protective coating on welded joints	m	95		
7.6	Provide 38mm G.I pipe between columns and for roof eave. Rate shall include all cuts, welds and fixing of these pipes	m	35.2		

7.7	Fixing of 75mm G.I pipe to support machine room & hazardous waste room door	m	5.6		
8	Painting works				
8.1	Applying primer and 2 paint coats on all fence walls	m2	147		
8.2	Applying primer and 2 paint coats on 1500 high walls of waste storage area	m2	40.5		
8.3	Applying primer and 2 paint coats on 3000 high walls of waste storage area	m2	206.7		
8.4	Applying epoxy paint coating on all metal surfaces.	LS	1		
9	Electrical works				
9.1	Provide 3 phase power sockets in equipment room. Rate shall include connection to circuit breaker	Nos	4		
9.2	Provide single phase power sockets in equipment room and hazardous waste room. Rate shall include connection to circuit breaker	Nos	3		
9.3	Provide 100mm ceiling mount light in hazardous waste room, including switch. Rate shall include connection to circuit breaker	Nos	1		
9.4	Provide wall mount exhaust fan in equipment room and hazardous waste storare room. Rate shall include properly fixing the the fan and connection to power socket	Nos	2		
9.5	Provide 500 W flood light for illuminating the waste yard. Rate shall include connecting each light to a weather proof switch and providing power to the switch	Nos	2		
9.6	Provide weather proof switch for all lights	Nos	3		
9.7	Supply and fix electric meter, 4 pole MCCB, Single Phase distribution board and 3 Phase distribution board as shown on drawing. Earth link and connection to earth rod with proper earth pit should be provided as well	LS	1		
9.8	Provide 25 sqmm 5 core power supply cable from nearest distribution box to waste yard distribution board	m	45		
9.9	Provide well water pump. Rate shall include its fixing and connection to power socket.	LS	1		
10	Doors and windows				

10.1	Provide metal door for entrance to equipment room. Rate shall include all cuts, welds, applying protective coating to welded joints, painting the door and proper fixing of the door. Rate shall include fixing of guide rails and wheels as well.	Nos	1		
10.2	Provide metal door for entrance to hazardous waste area. Rate shall include all cuts, welds, applying protective coating to welded joints, painting the door and proper fixing of the door. Rate shall include fixing of guide rails and wheels as well.	Nos	1		
10.3	Provide metal door for entrance to waste yard. Rate shall include all cuts, welds, applying protective coating to welded joints, painting the frame and properly fixing the door to the fence.	Nos	1		
11	Roofing				
11.1	Supply and fix roof sheets for waste storage area as shown on drawing	m2	85.5		
11.2	Provide flashing sheet on all areas required for roofing area	m	28		
11.3	Provide and fix lysaght gutter	m	19		
11.4	Provide conveyance pipe from down pipe point to water well	LS	1		
11.5	Provide and fix 75mm down pipe	nos	2		
12	Plumbing				
12.1	Provide footvale and 25mm PVC intake pipe for pump from well	LS	1		
12.2	Provide metal tap for distribution points in waste yard as shown on drawing. Rate shall include fixing the tap to boundary wall.	Nos	3		
12.3	Provide 1/2 inch PVC pipe from pump to all distribution points. Rate shall include all joints, bends and burrying the pipe 300mm below ground	LS	1		
13	Others				
13.1	50 x 50 PVC coated mesh for fence. Rate shall include properly securing the mesh to G.I steel frame	m2	105		
13.2	Provide HDPE membrane below compost slab	m2	150		
13.3	Provide HDPE membrane below waste storage area slab	m2	60		
13.4	Provide timber top cover over leachate collection tank	Nos	2		
13.5	Cut and place PVC pipe in drain as shown on drawing	m	15		

13.6	Fabricate and Install 600 x 900 sign board on 5mm plastic sheet. All letters, logos and symbols used on the board should be spray painted	LS	1		
13.7	Provide expansion joint as shown on drawing and fill the gaps as indicated	m	25		

TOTAL

PROVISION OF WATER SUPPLY SANITATION AND SOLID WASTE MANAGEMENT PROJECT

H.DH KUMUNDHOO ISLAND WASTE MANAGEMENT CENTER



SOLID WASTE MANAGEMENT COMPONENT
OF ID PROJECT
MINISTRY OF ENVIRONMENT AND ENERGY

HANDHUVAREE HINGUN MALE' 20-01
REPUBLIC OF MALDIVES

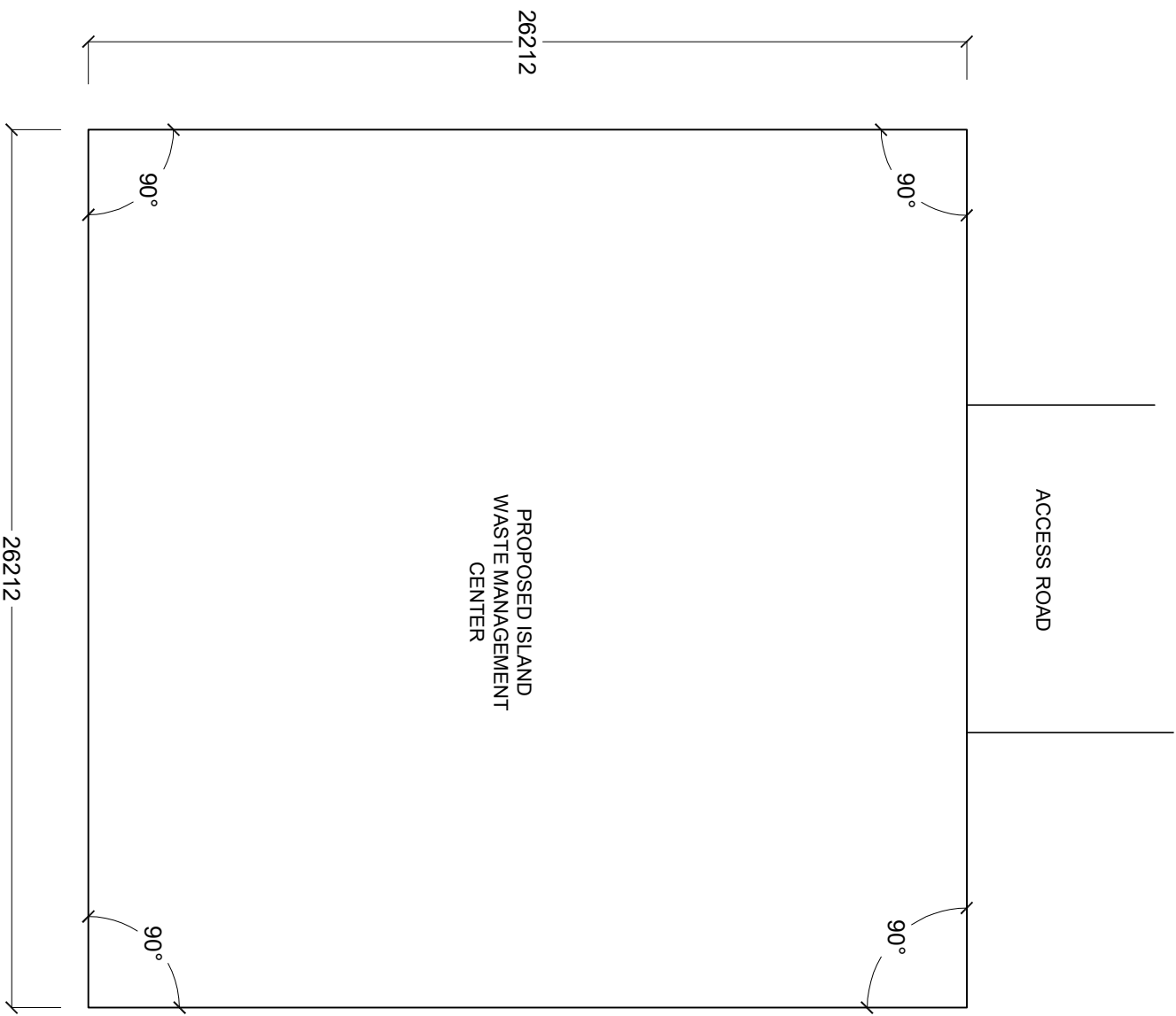

SITE PLAN
1:200

PROVISION OF WATER SUPPLY SANITATION AND SOLID WASTE MANAGEMENT PROJECT
OPEC FUND FOR INTERNATIONAL DEVELOPMENT

PROJECT:
H.D.H KUMUNDHOO ISLAND WASTE MANAGEMENT CENTER

SCALE: AS SHOWN
DATE: MAR 2017



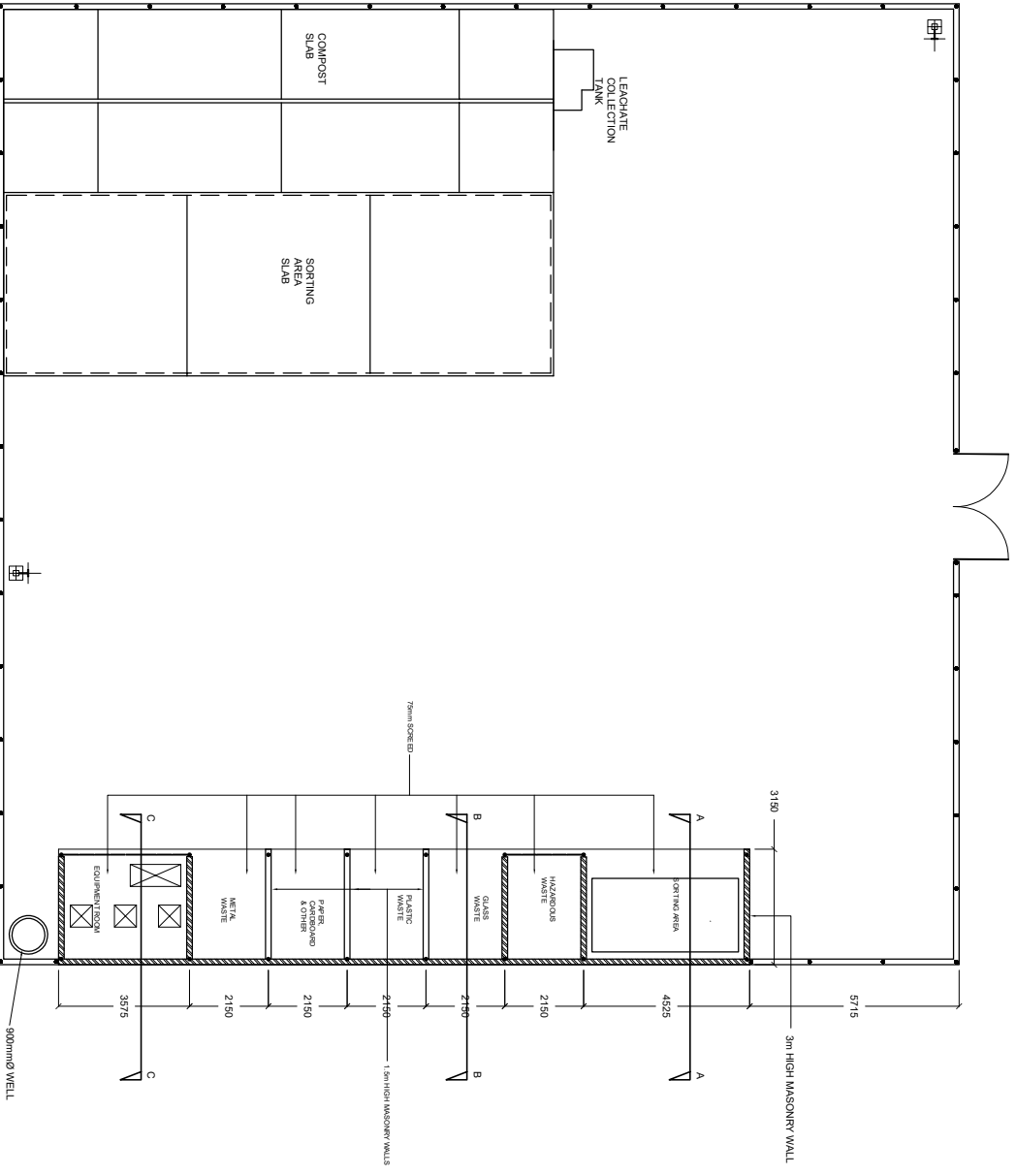

IMMC LAYOUT
1:200

PROVISION OF WATER SUPPLY SANITATION AND SOLID WASTE MANAGEMENT PROJECT
OPEC FUND FOR INTERNATIONAL DEVELOPMENT

PROJECT:
H.DH KUMUNDHOO ISLAND WASTE MANAGEMENT CENTER

SCALE: AS SHOWN
DATE: MAR 2017



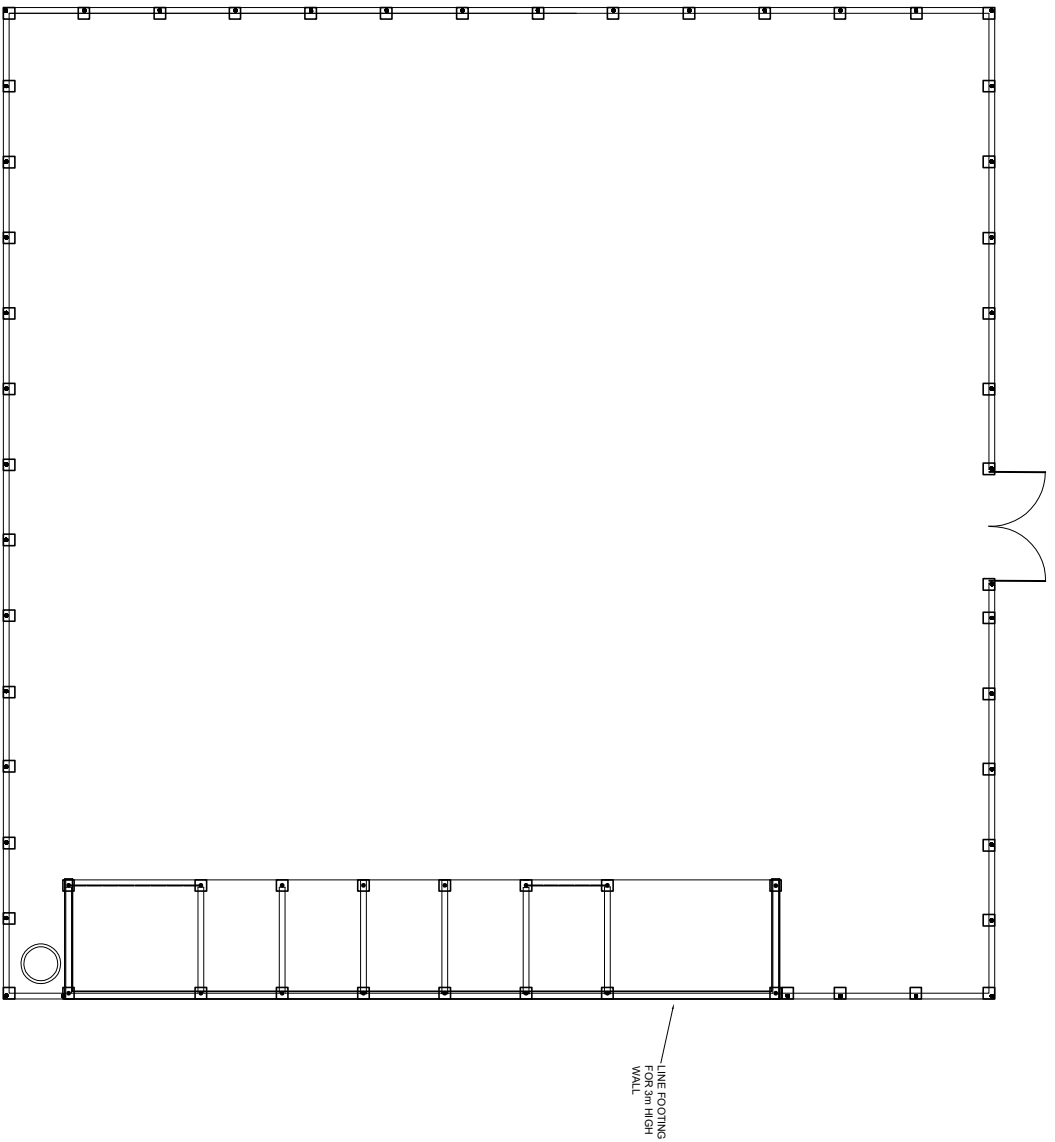

FENCE FOUNDATION AND COLLECTION
AREA FOUNDATION

1:200

PROVISION OF WATER SUPPLY SANITATION AND SOLID
WASTE MANAGEMENT PROJECT
OPEC FUND FOR INTERNATIONAL DEVELOPMENT

PROJECT:
H:DH KUMUNDHOO ISLAND WASTE MANAGEMENT CENTER

SCALE: AS SHOWN

DATE: MAR 2017



STATE WATER MANAGEMENT COMMISSION
OF MALDIVES
MINISTRY OF ENVIRONMENT AND ENERGY
PROVIDING WATER, SANITATION AND ENERGY
FOR ALL MALDIVES

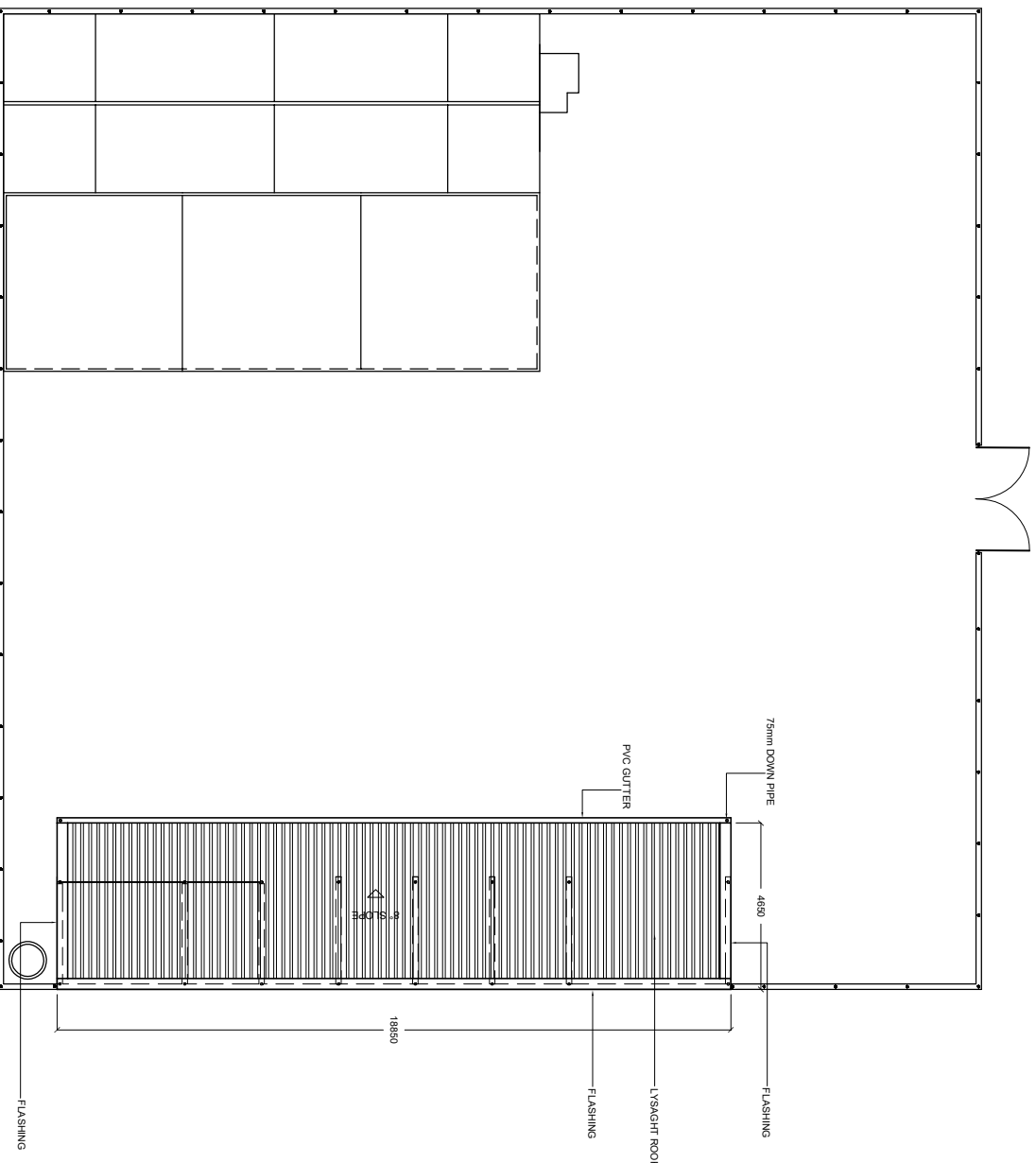

ROOF PLAN
1:200

PROVISION OF WATER SUPPLY SANITATION AND SOLID WASTE MANAGEMENT PROJECT
OPEC FUND FOR INTERNATIONAL DEVELOPMENT

PROJECT:
H/DH KUMUNDHOO ISLAND WASTE MANAGEMENT CENTER

SCALE: AS SHOWN
DATE: MAR 2017

SOLID WASTE MANAGEMENT DIVISION
MINISTRY OF ENVIRONMENT AND ENERGY
MALDIVES
1995203
1995203

ROOF FRAMING LAYOUT
1:200

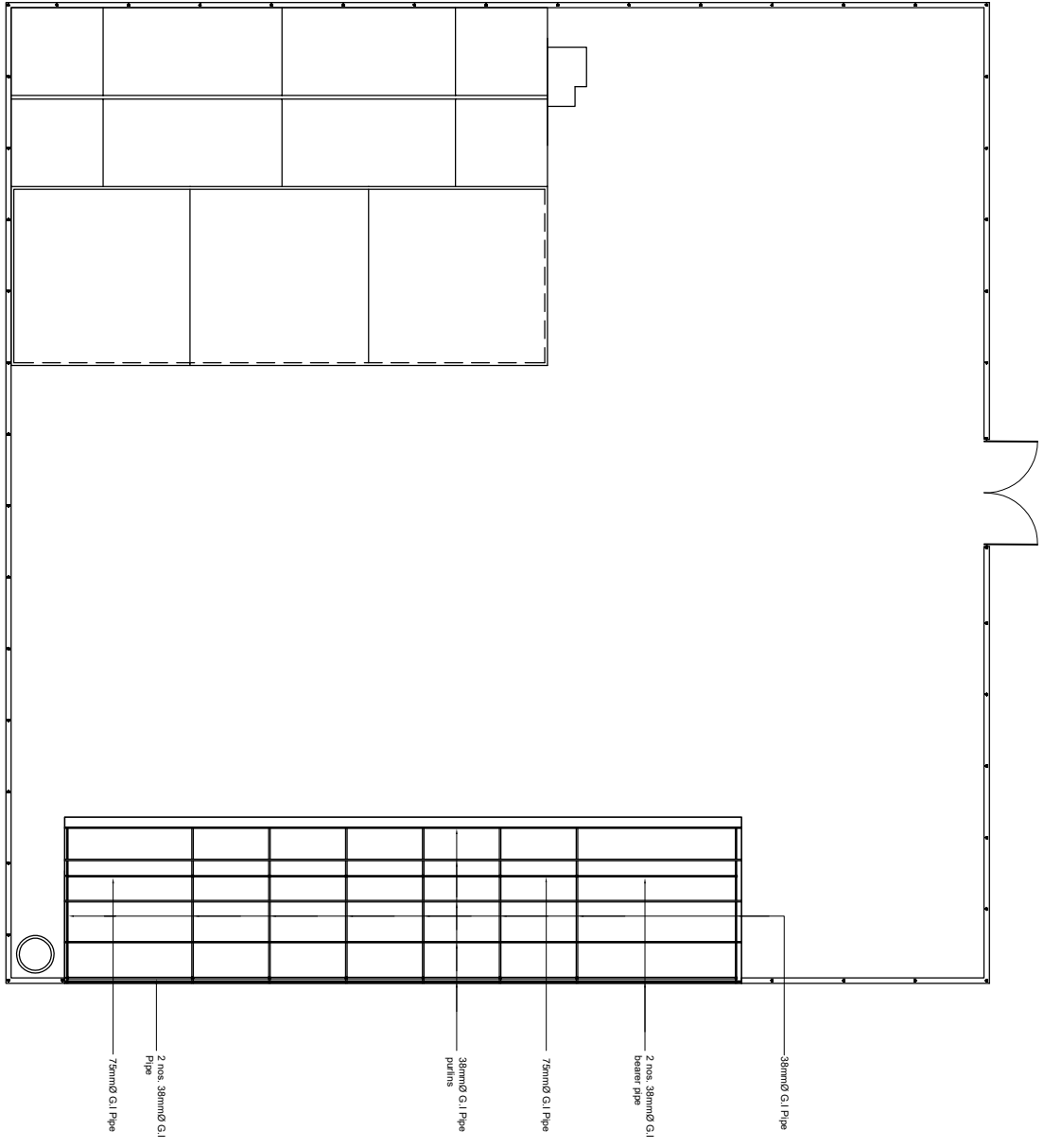

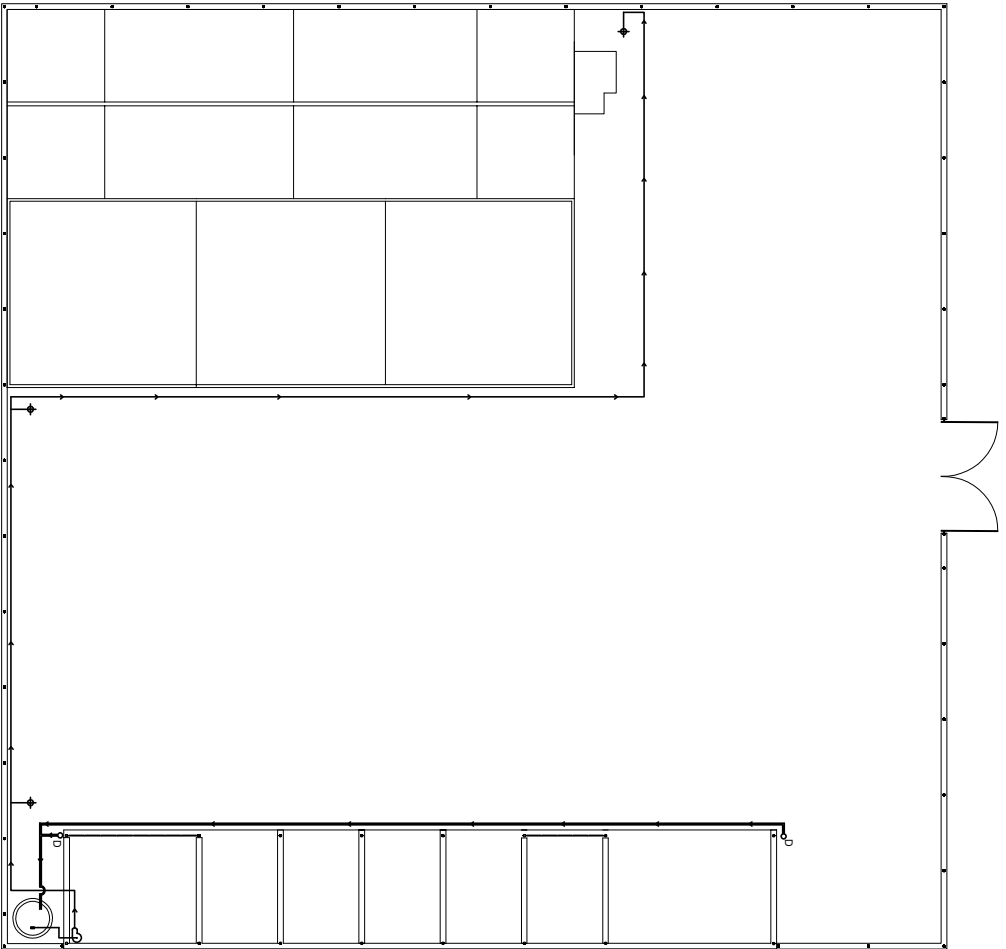

- 75mm Conveyance pipe
- Down pipe
- ⊕ Foot valve
- ⊕ Shallow well pump (220 V, 550 W)
- ⊕ Metal tap

PLUMBING LAYOUT

1:200

PROVISION OF WATER SUPPLY SANITATION AND SOLID WASTE MANAGEMENT PROJECT
 OPEC FUND FOR INTERNATIONAL DEVELOPMENT

PROJECT:
 H:DH KUMUNDHOO ISLAND WASTE MANAGEMENT CENTER

SCALE: AS SHOWN
 DATE: MAR 2017



ELECTRICAL LAYOUT
 1:200

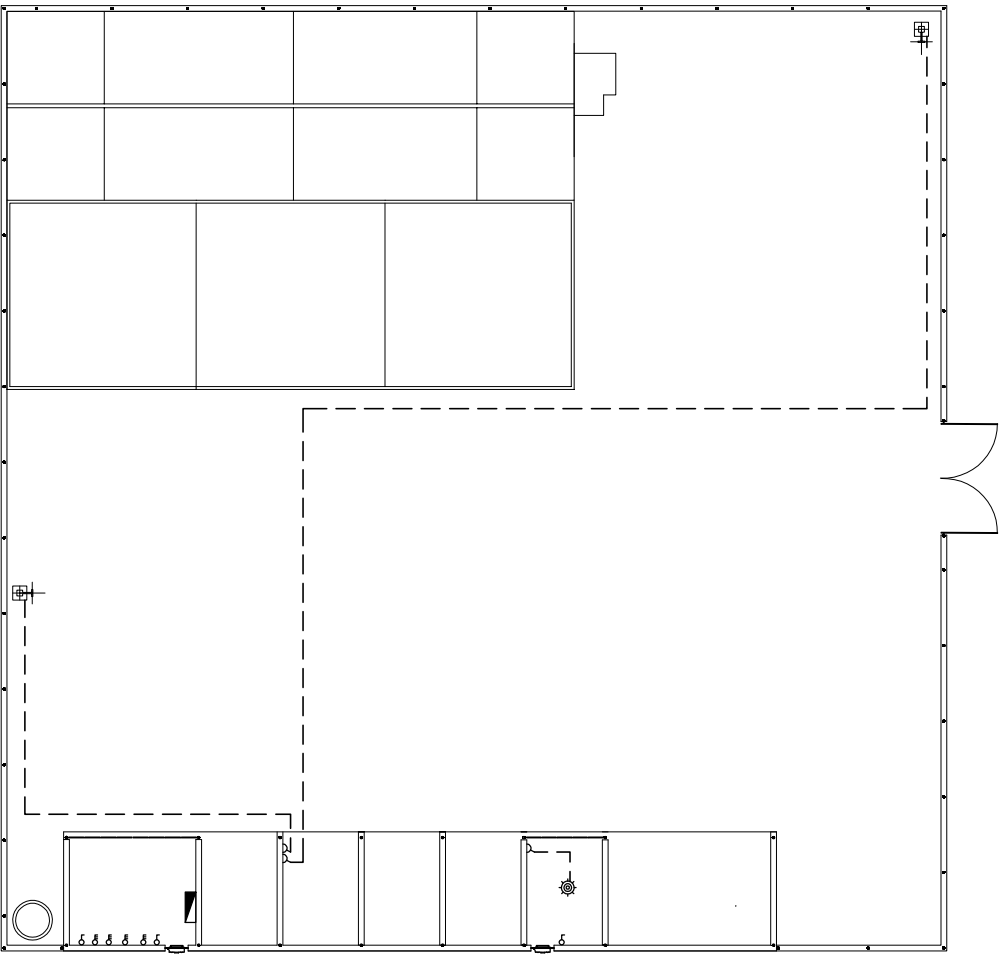

- DISTRIBUTION BOARD
- 100W ENERGY SAVING LIGHT
- 3 PHASE POWER POINTS
[1m ABOVE GROUND]
- 1 PHASE POWER POINTS
[1m ABOVE GROUND]
- WEATHER PROOF SWITCH
- EXHAUST FAN
(14" blade diameter,
230 V, 250 W)

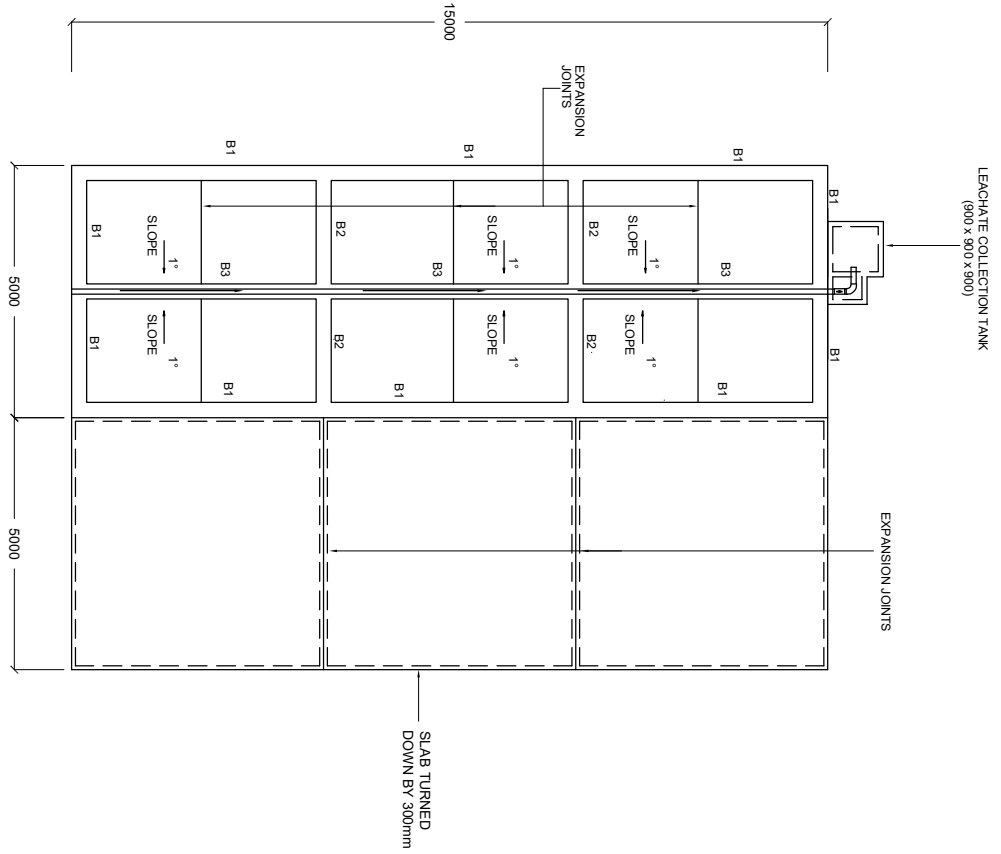

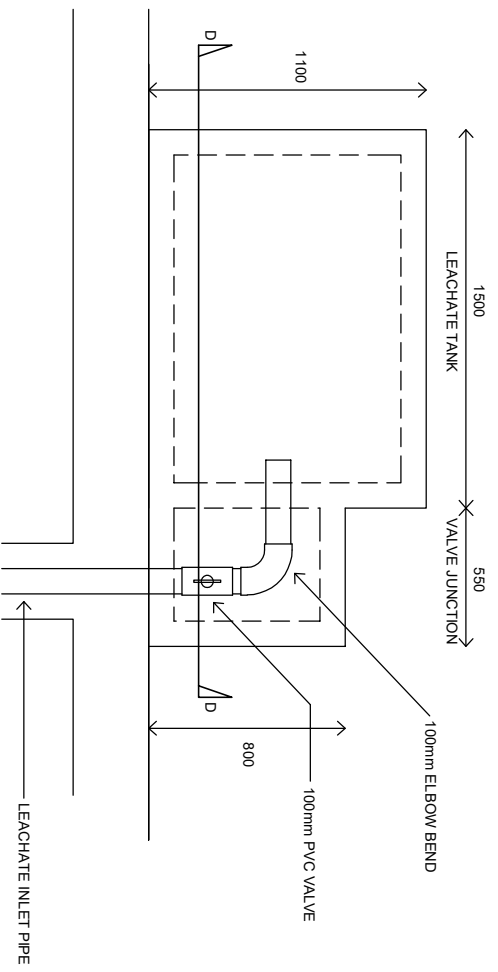

LEACHATE TANK DETAIL
1:30

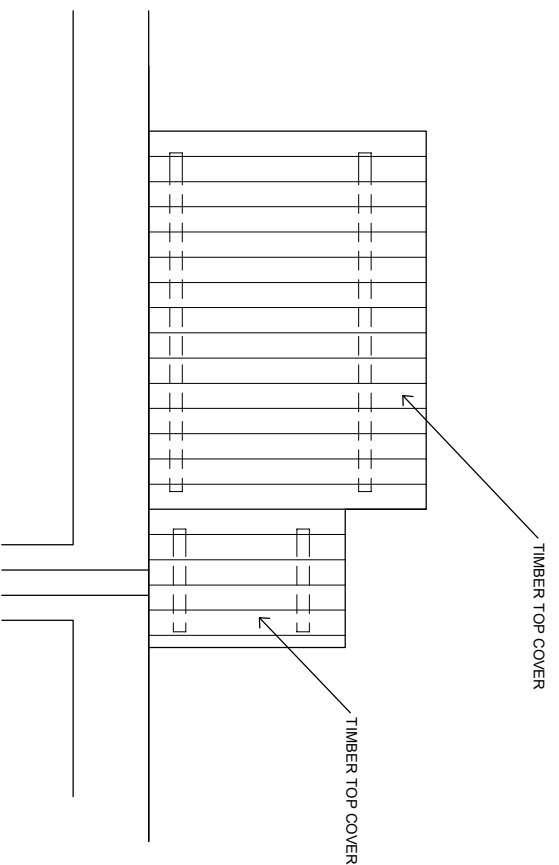

LEACHATE TANK COVER
1:30

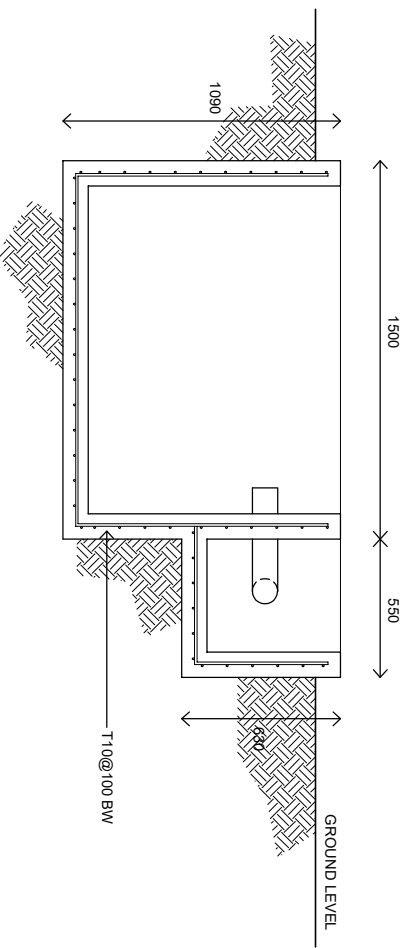

SECTION D
1:30

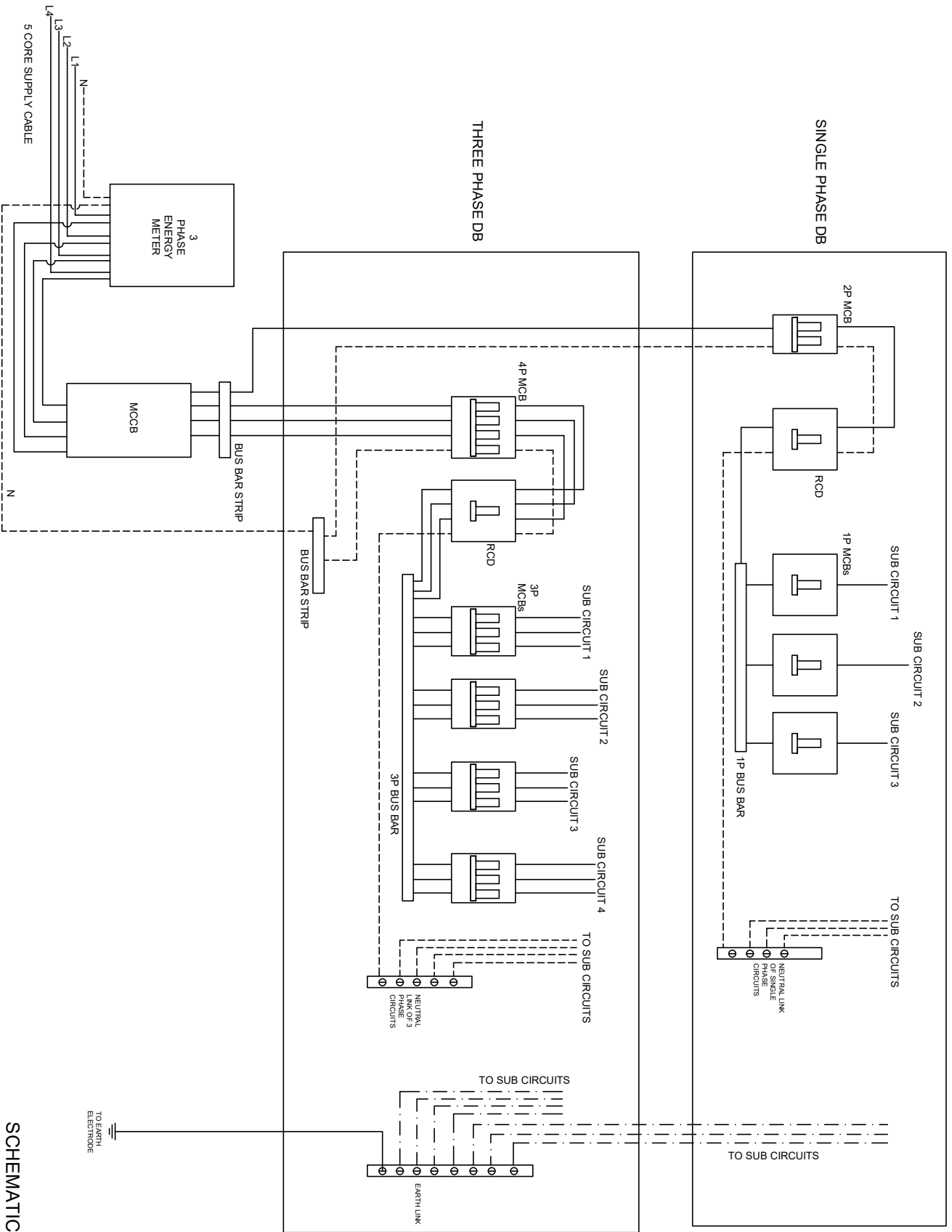

SCHEMATIC WIRING DIAGRAM

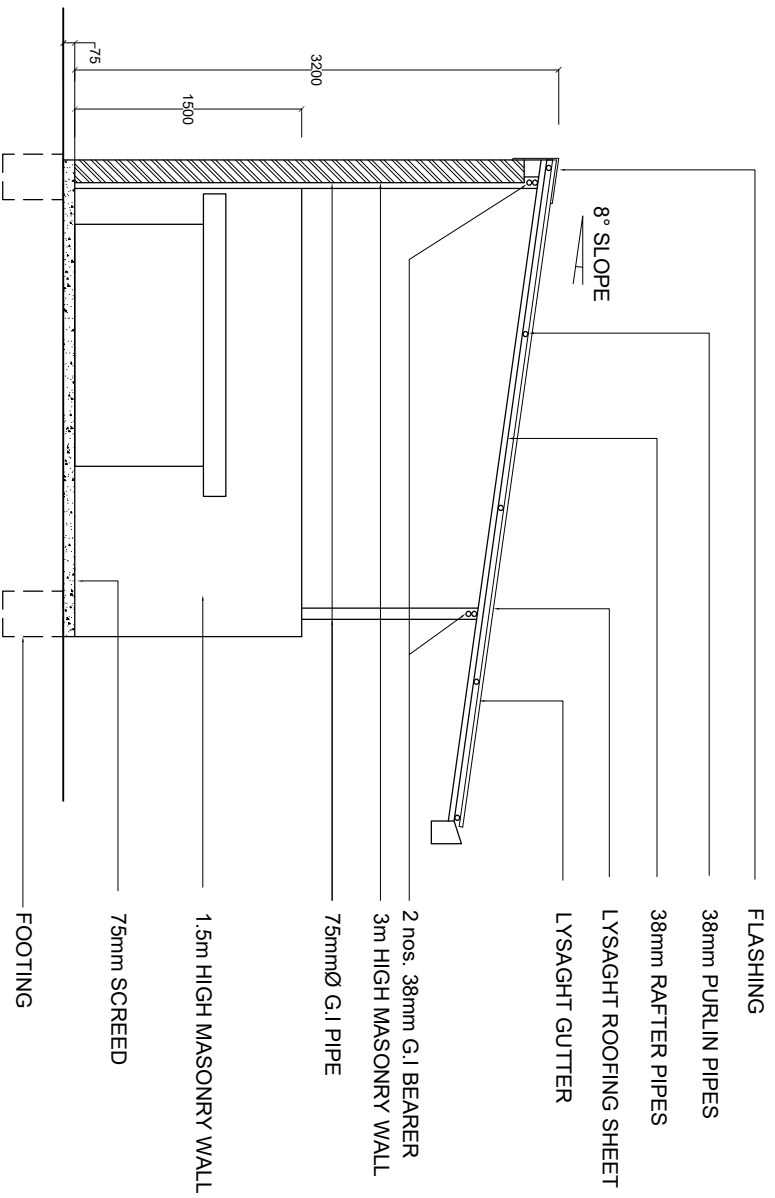

SECTION A
1:50

SEC
1:5

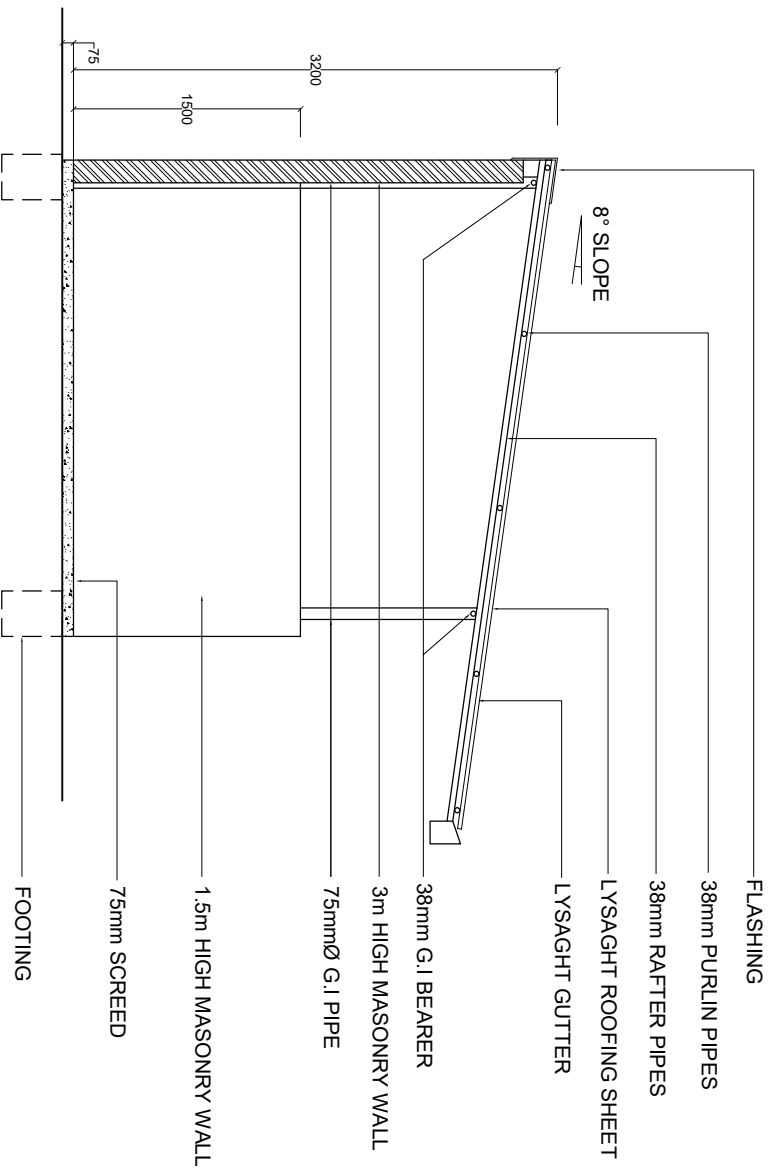

SECTION B
1:50

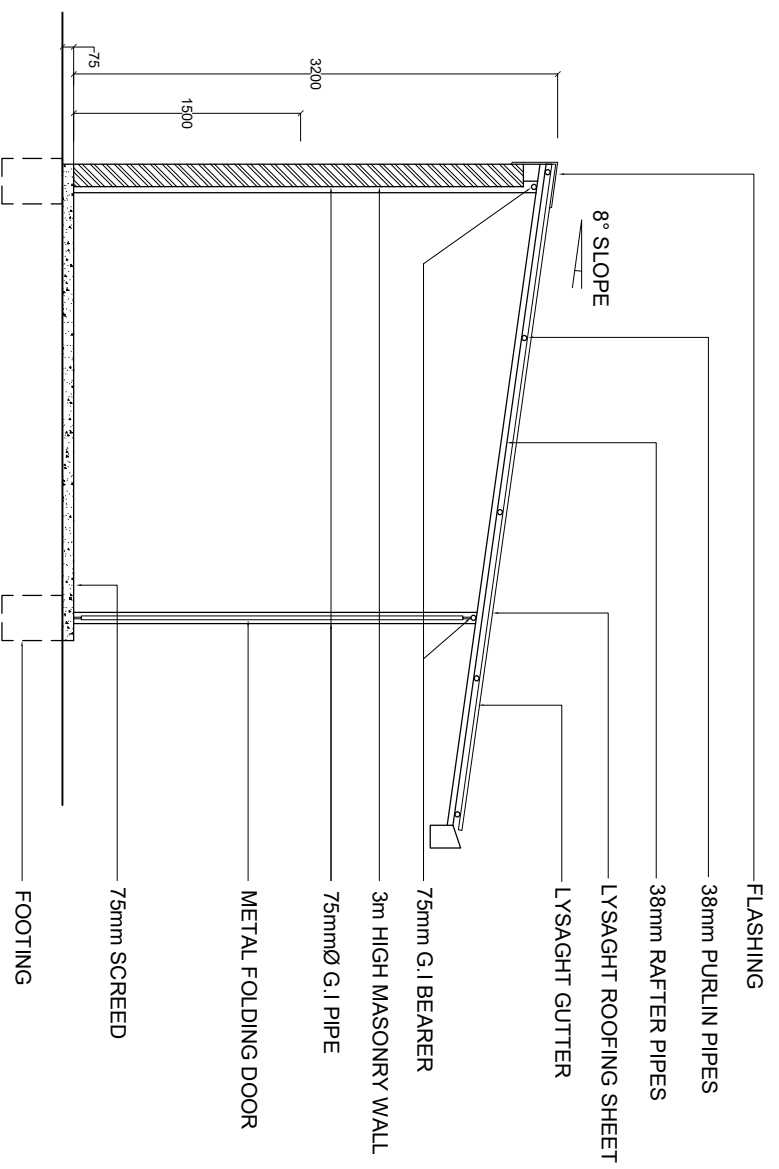

SECTION C
1:50

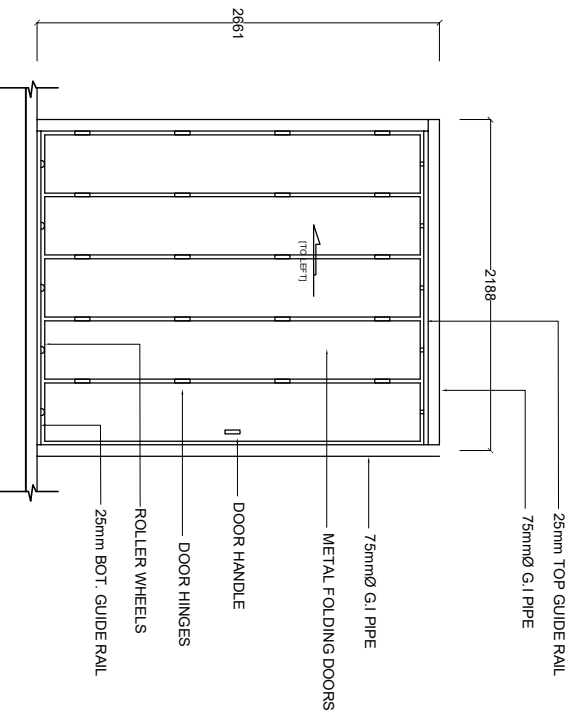

**HAZARDOUS WASTE AREA
FOLDING DOOR DETAIL**
1:50

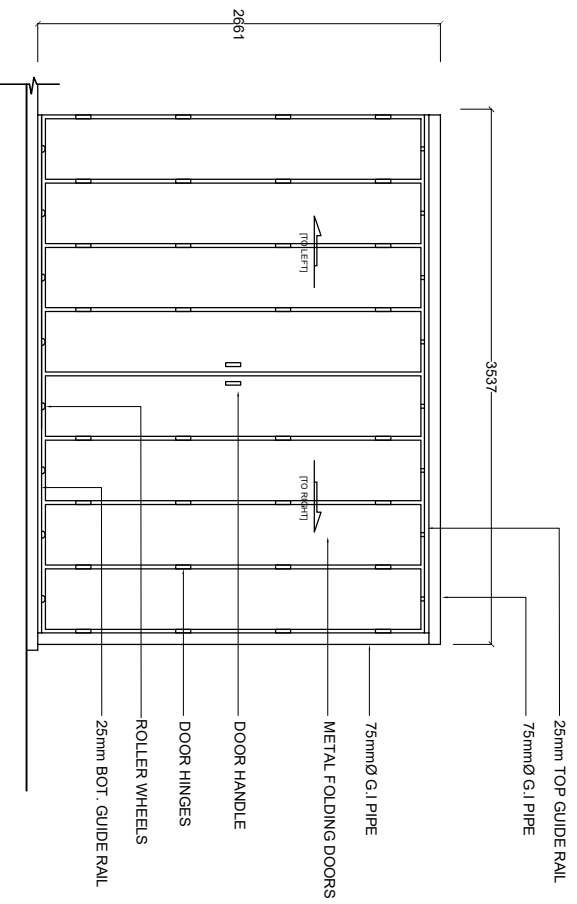

**EQUIPMENT ROOM
FOLDING DOOR DETAIL**
1:50

ENTRANCE / EXIT GATE
1:50

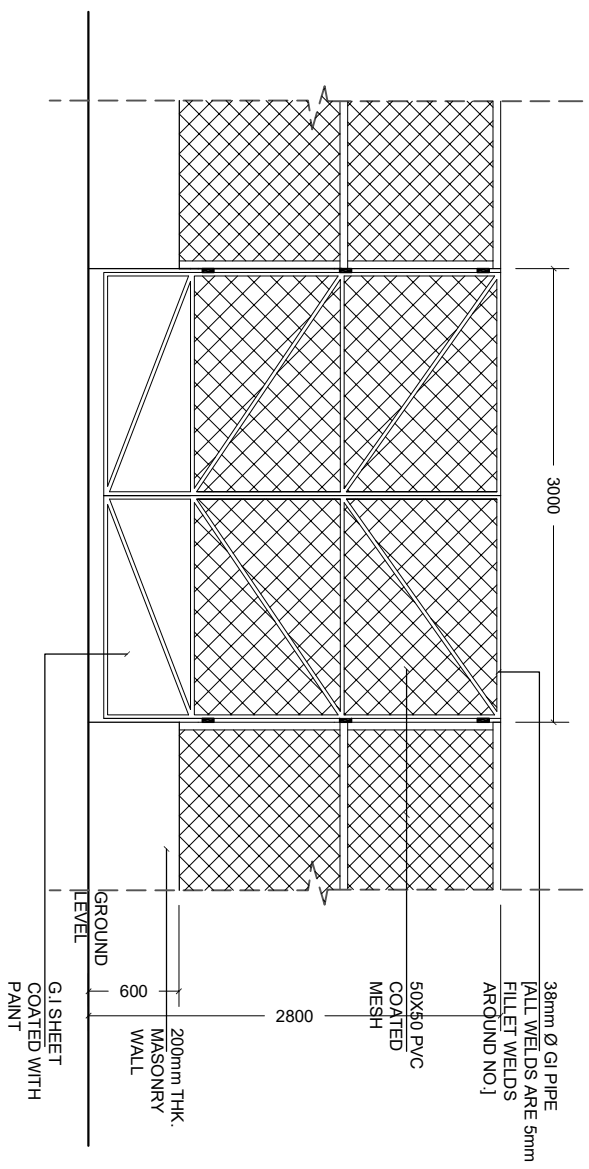

PERIMETER FENCE
1:50

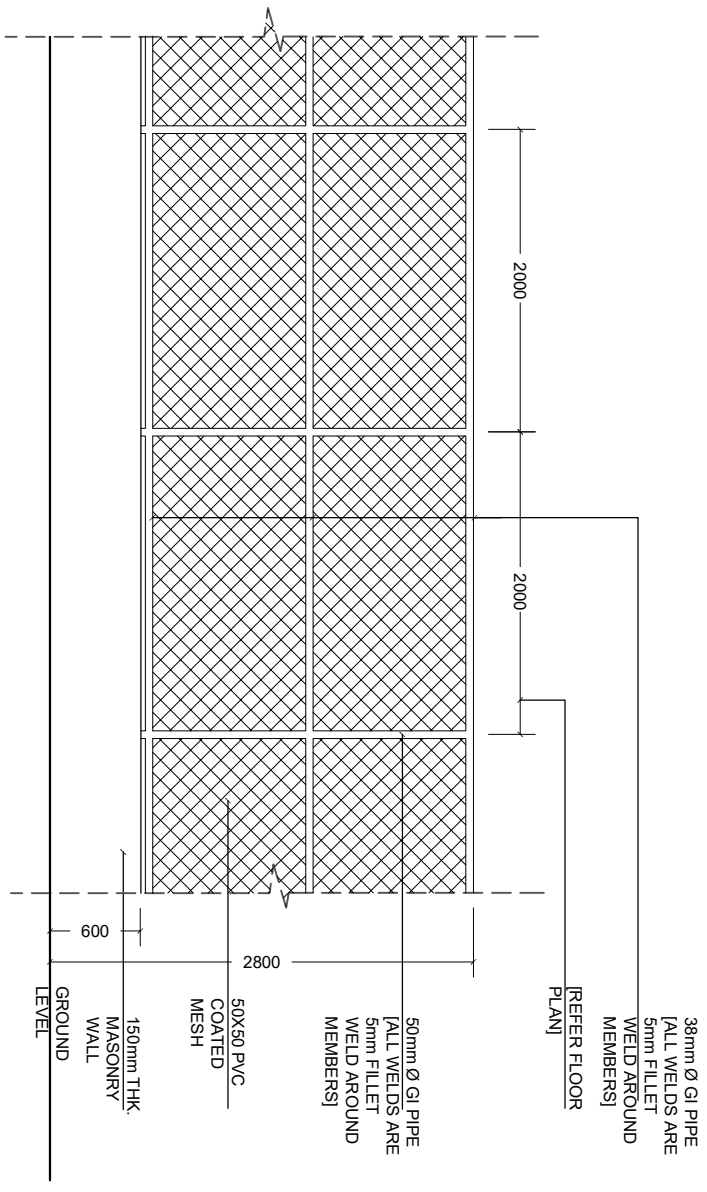

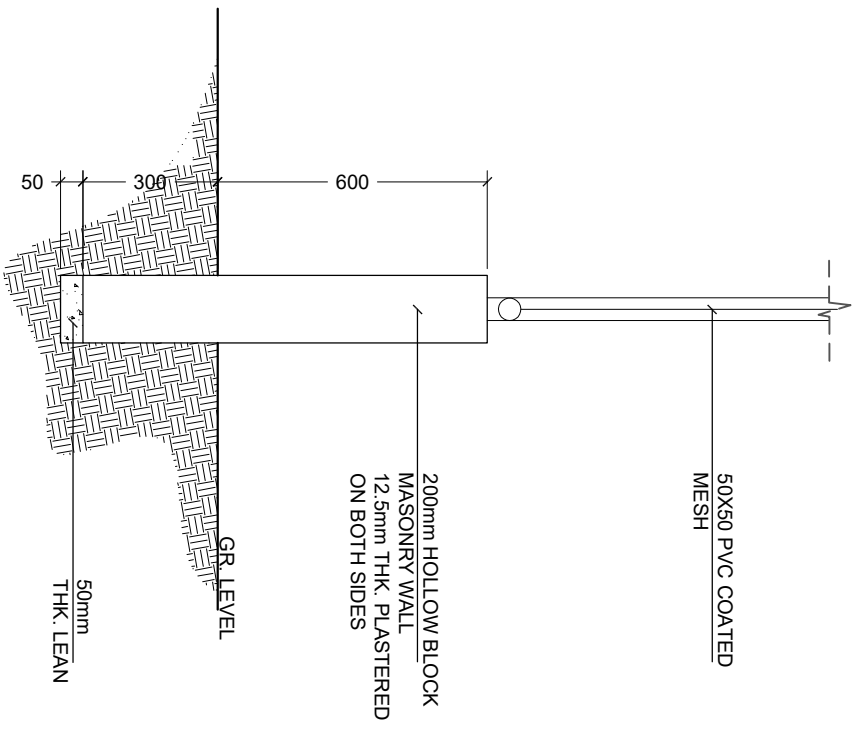
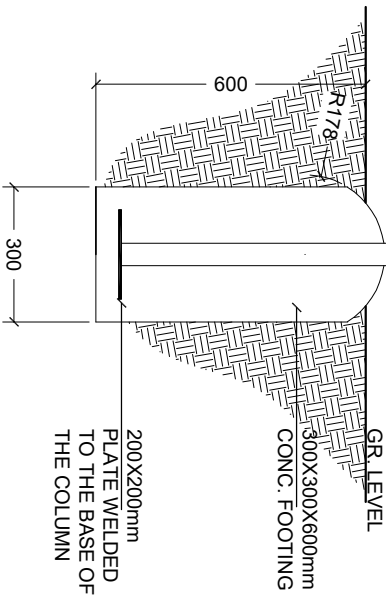
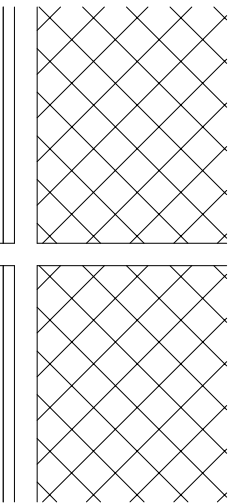

FENCE FOUNDATION DETAIL

PERIMETER WALL FOUNDATION DETAIL

PROVISION OF WATER SUPPLY SANITATION AND SOLID
WASTE MANAGEMENT PROJECT
OPEC FUND FOR INTERNATIONAL DEVELOPMENT

PROJECT:
H.DH KUMUNDHOO ISLAND WASTE MANAGEMENT CENTER

SCALE: AS SHOWN
DATE: MAR 2017



WASTE SORTING AREA
COLUMN FOUNDATION DETAIL

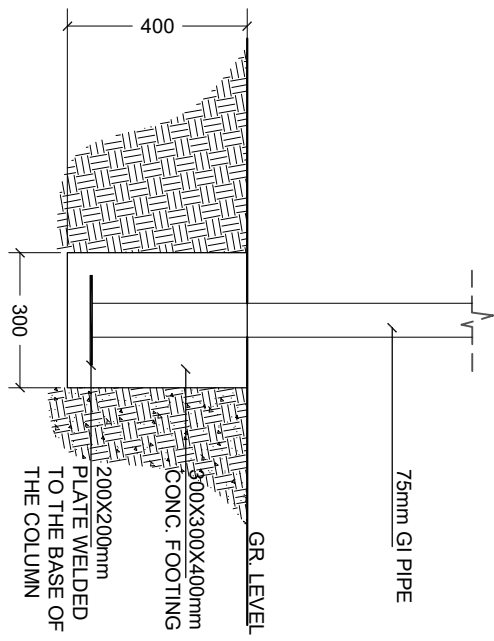

LIGHT POST FOUNDATION

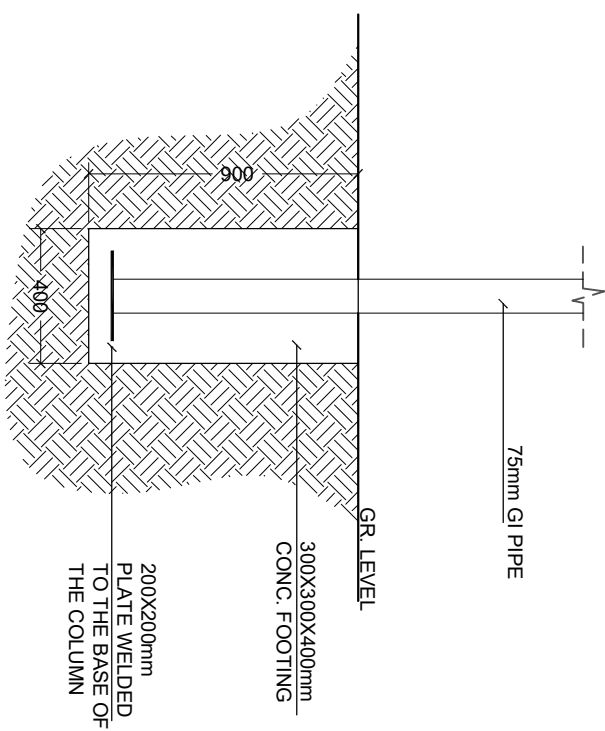

PROVISION OF WATER SUPPLY SANITATION AND SOLID
WASTE MANAGEMENT PROJECT
OPEC FUND FOR INTERNATIONAL DEVELOPMENT

PROJECT:
H.DH KUMUNDHOO ISLAND WASTE MANAGEMENT CENTER

SCALE: AS SHOWN
DATE: MAR 2017



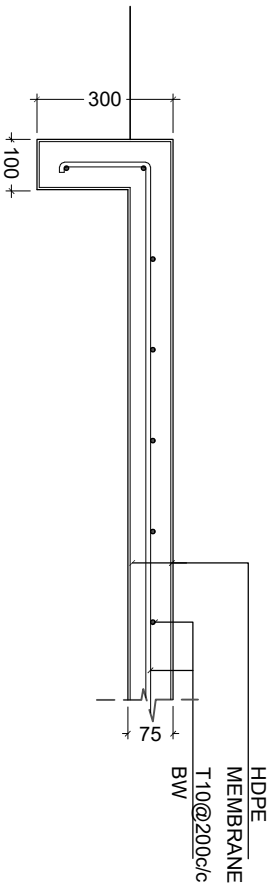
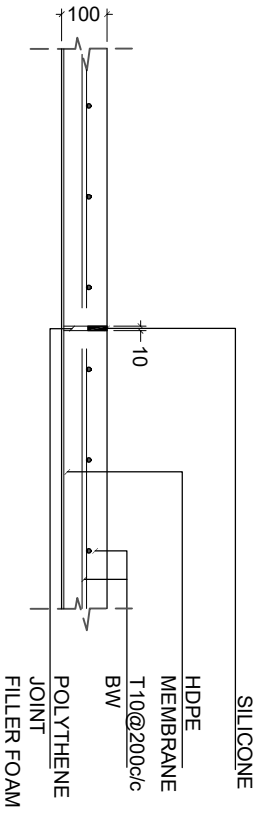
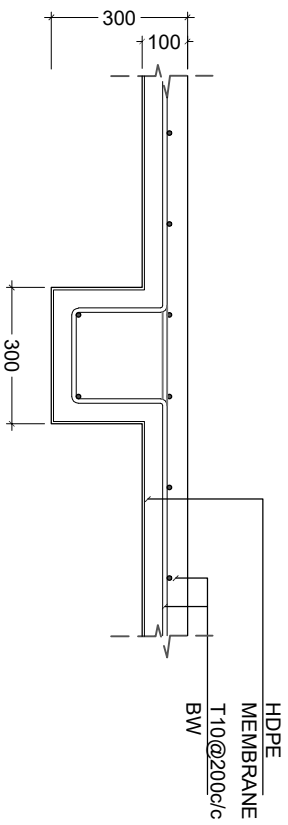
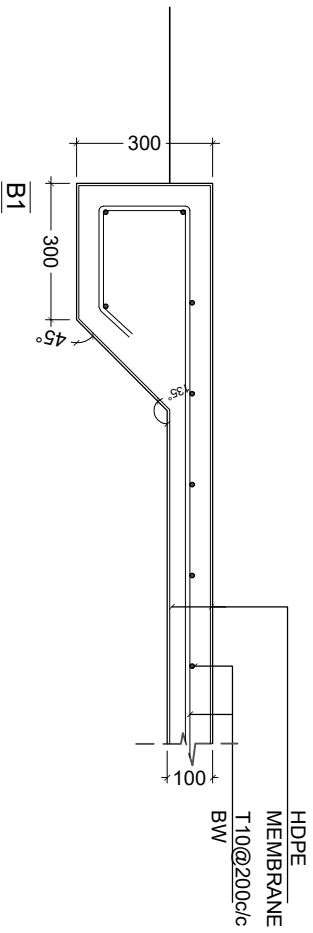

100MM PVC PIPE CUT IN
 HALF WITH 1% SLOPE TO
 LEACHATE WELL

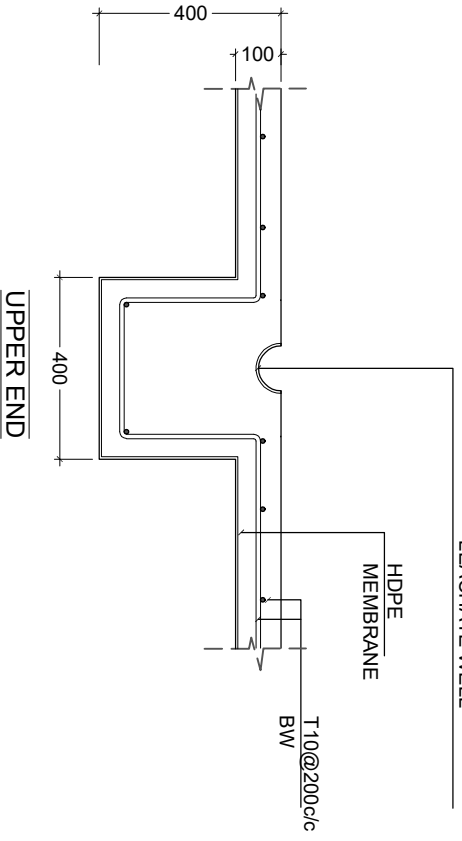

100MM PVC PIPE CUT IN
 HALF WITH 1% SLOPE TO
 LEACHATE WELL

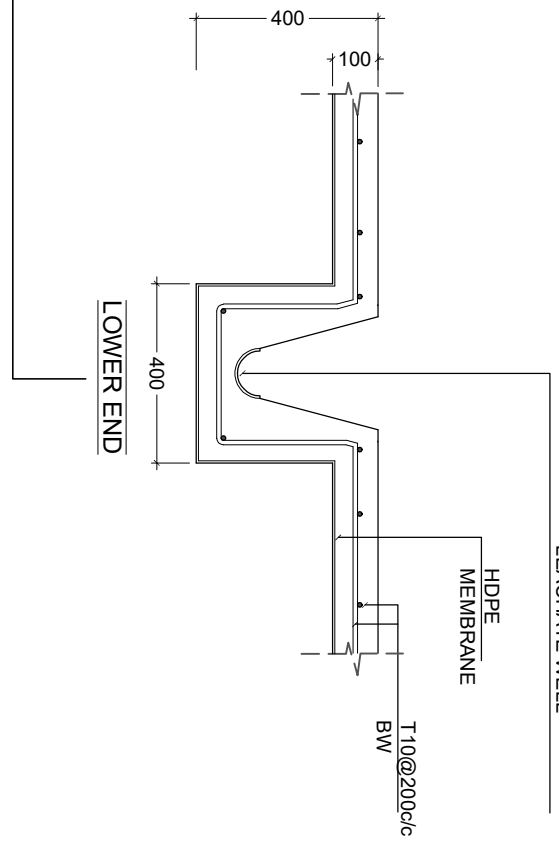

B3

HDPE
 MEMBRANE
 R6@1500/c
 BW

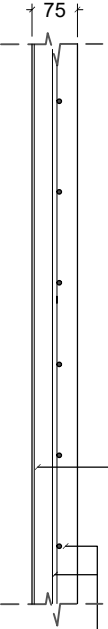

2T112
 R6@150
 2T112

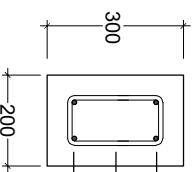

PROVISION OF WATER SUPPLY SANITATION AND SOLID

WASTE MANAGEMENT PROJECT

OPEC FUND FOR INTERNATIONAL DEVELOPMENT

PROJECT:

H:DH KUMUNDHOO ISLAND WASTE MANAGEMENT CENTER

SCALE: AS SHOWN

DATE: MAR 2017



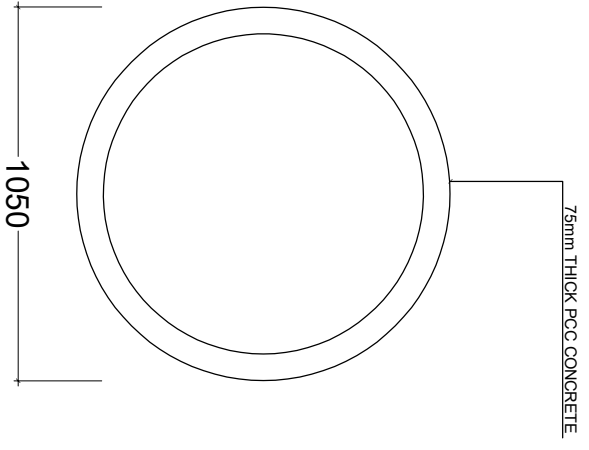

GROUND WATER WELL

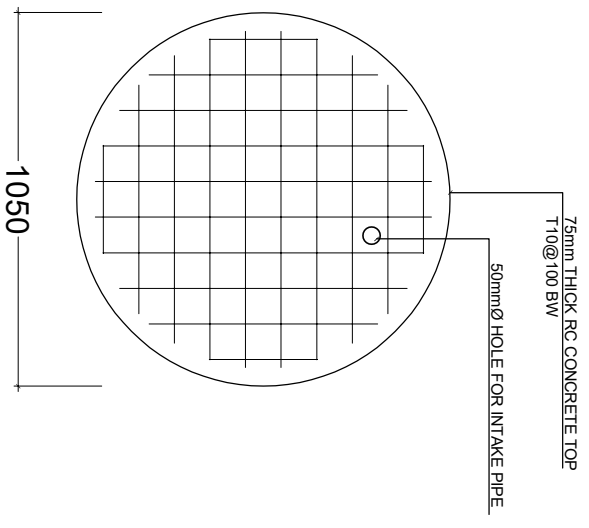

GROUND WATER WELL - TOP

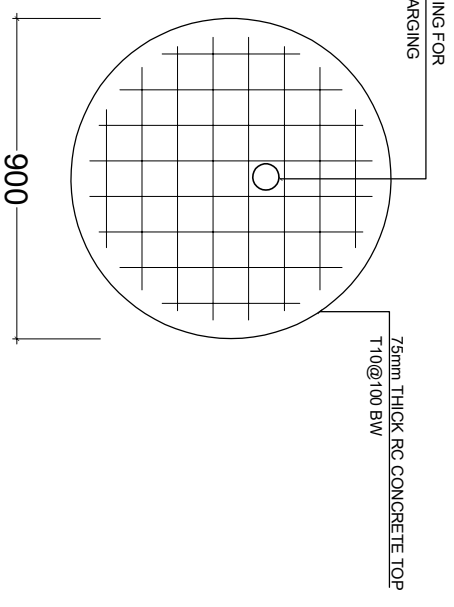

GROUND WATER WELL - BASE

PROVISION OF WATER SUPPLY SANITATION AND SOLID WASTE MANAGEMENT PROJECT
 OPEC FUND FOR INTERNATIONAL DEVELOPMENT

PROJECT:
 H.DH KUMUNDHOO ISLAND WASTE MANAGEMENT CENTER

SCALE: AS SHOWN
 DATE: MAR 2017



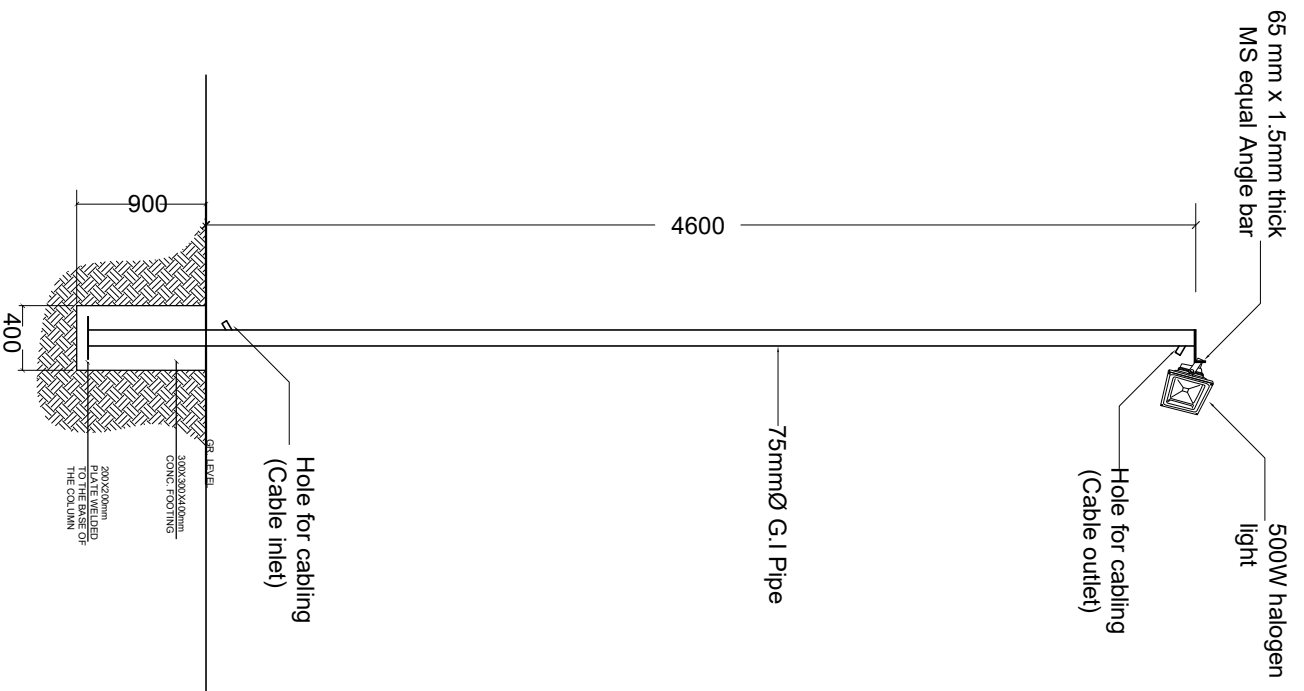

LIGHT POST DETAIL

* GI pipe to be painted with 1 coat of sealer & 2 coats of finishing paint. (Sigma, Grey colour)

Ministry of Environment and Energy

Male', Republic of Maldives.

Provision of Water Supply, Sanitation and Solid Waste Management Project

Establishment of Island Waste Management Center (IWMC) in H. Dh. Kumundhoo

TECHNICAL SPECIFICATIONS – H.DH. KUMUNDHOO

Working Site

The site should be kept clean during the construction work period and should be thoroughly cleaned once the works are completed. Works should be carried out on site in a safe manner to all the workers on site and the people living in the vicinity of site. Disturbance to the neighborhood should be kept to a minimum. Electricity and water supply to the site, during construction period, should be provided by the contractor

Concrete

1. Cement conforming to BS12 standards should be used for all concrete, masonry and plastering works. The cement intended for use should be fresh and should not have any traces of hardened cement in the bag.
2. All concrete works should be done using one brand of cement
3. Sand and aggregate used for concrete works should be well graded.
4. Concrete should be mixed in the ratio 1:2:3 which are 1 part cement, 2 parts sand and 3 parts aggregate.
5. All foundations should be cast on a lean concrete layer. The lean concrete should be placed on well compacted ground.
6. Concrete should be mixed using a concrete mixer. Concrete should not be mixed by hand. When pouring concrete into the formwork, the mix should be compacted using a mechanical vibrator.
7. Aggregate used for concrete works should not be larger than 20mm.
8. Sand and aggregate used for concrete works should be clear from dust, mud and other debris.
9. All reinforcement bars used for the concrete works should be free from rust and grease that could weaken the bonding between the reinforcement bar and the concrete. Care should be taken to use continuous bars rather than short segments joined by laps.

Ministry of Environment and Energy

Male', Republic of Maldives.

Masonry Works

1. All masonry work should be done using Cement confirming to BS12 standards.
2. Masonry blocks should be made from imported sand or local white sand sourced from a permitted sand borrow area. The sand should be free from organic matter and other debris.
3. Masonry blocks should be made from mortar mixed at 1:5 ratio with 1 part cement to 5 part sand.
4. Average size of sand particles should not exceed 5mm.

Plastering Works

1. All plastering work should be done using Cement confirming to BS12 standards.
2. Plaster mix should be made from imported or local sand white sand sourced from a permitted borrow area. The sand should be free from organic matter and other debris.
3. Plaster mix should be made by mixing Cement and Sand at a ratio of 1:3 with 1 part Cement to 3 part Sand.
4. Average size of sand particles should not exceed 5mm.

Structural Steel work

1. All steel pipes obtained for the work should be new pipes and free from rust.
2. Thickness of pipes should not be less than 2.5mm

Electrical works

1. All materials used for electrical wiring should comply with MEA standards.

Roofing works

1. All materials used for roofing work should be newly purchased for the project.
2. All screws or bolts used for roof fixing should be G.I or Zinc finish screws.